

# ARMAND



**Signature**  
— BY EOL —



## FONCTIONNEL & VARIÉ

**A** RMAND est une gamme de rangements pratiques à l'esthétique soignée qui permet d'optimiser l'organisation des bureaux et structurer les espaces de travail. Avec ses nombreuses finitions et sa large palette de coloris, ARMAND est ultra-personnalisable pour répondre à toutes les demandes des utilisateurs ainsi qu'à leurs besoins d'aménagement.

---

## FUNCTIONAL & DIVERSE

**A** RMAND is a practical range of storage furniture with a carefully considered design that helps optimise the organisation of workstations and the structuring of workspaces. Supported by an extensive selection of finishes and a comprehensive colour palette, ARMAND is an ultra-customisable furniture range capable of fulfilling every user requirement.

---

## FUNCTIONEEL & GEVARIEERD

**A** RMAND staat voor praktisch en elegant opbergmeubilair voor een optimale kantoororganisatie én indeling van de werkruimte. Dankzij het ruime aanbod aan afwerkingen en kleuren is ARMAND perfect personaliseerbaar en biedt de collectie een antwoord op de meest diverse noden van de gebruikers.

---

**DES RANGEMENTS POUR TOUS LES USAGES**  
**STORAGE SOLUTIONS FOR EVERY NEED**  
**OPBERGMEUBILAIR VOOR ALLE TOEPASSINGEN**



Créer une bibliothèque partagée  
Create a shared library using  
bookcase units  
Een gedeelde boekenkast creëren



Optimiser l'archivage  
Optimise your filing system  
Optimaal archiveren



Séparer les espaces grâce aux rangements de proximité  
Create separate spaces using easy-reach storage units  
Ruimten indelen met behulp van opbergmeubilair



Aménager les espaces de direction  
Furnish office spaces for management  
Directiekantoor inrichten

**JOUER** AVEC LES COMBINAISONS  
**PLAY** WITH DIFFERENT COMBINATIONS  
**SPELEN** MET COMBINATIES



Grâce à son large choix de décors, ARMAND se décline en de multiples combinaisons unies et bicolores pour dynamiser votre environnement de travail. Pour assurer une esthétique commune au sein des différents espaces de travail, il est également possible d'assortir le top des armoires ARMAND (hauteur bureau) au plateau de vos bureaux.

Thanks to an extensive choice of finishes, ARMAND can be specified to multiple unified or two-tone colour schemes that will energise your workplace. To ensure a unified and harmonious visual aesthetic throughout different workspaces, it is also possible to fit ARMAND cupboards (desk height) with decorative tops in a finish that matches the desk tops.

Dankzij het ruime aanbod van decors is ARMAND leverbaar in talrijke eenkleurige én tweekleurige combinaties die dynamiek toevoegen aan de werkomgeving. Voor een harmonieuze esthetiek in uw kantoorruimte kunnen de topbladen van de opbergmeubels van ARMAND (bureauhoogte) aangepast worden aan de bureaubladen.

**DES FINITIONS SOIGNÉES**  
**HIGH QUALITY FINISH**  
**AFWERKINGEN MET OOG VOOR DETAIL**



Rail pour portes coulissantes  
Rail for sliding doors  
Rail voor schuifdeuren

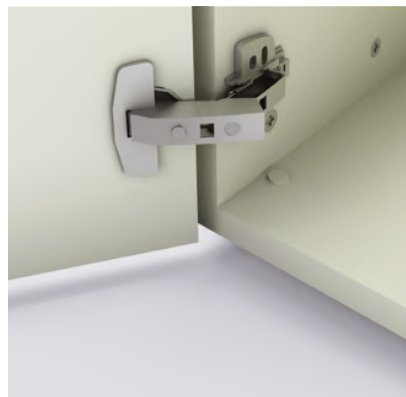

Charnière auto-freinée et antibruit  
Silent and self-damping hinge  
mechanism  
Zelfremmende en geluiddempende  
scharnier



Tablette mélamine et métal  
Table combining melamine with metal  
Melamine en metalen legbord



Poignée en aluminium  
Stainless aluminium handle  
Aluminium handgreep

**PERSONNALISER** ARMAND  
**CUSTOMISE** ARMAND  
ARMAND **PERSONALISEREN**



Avec sa large palette de coloris et ses différentes finitions, ARMAND est ultra personnalisable et s'adapte à tous les styles. Afin d'organiser votre rangement, vous pouvez ajouter des tablettes métal ou mélamine et un châssis télescopique pour dossiers suspendus. Au-delà de sa fonction de rangement, la gamme ARMAND dispose d'accessoires permettant de gagner en praticité et esthétique comme le top mélamine ou le coussin d'assise.

Supported by an extensive colour palette and selection of finishes, ARMAND is an ultra-customisable furniture range that adapts to all design styles. To help better organise your storage you can add metal and melamine shelves, as well as a telescopic suspension file cradle. Beyond the mere storage functionality, the ARMAND range also features accessories that will further enhance its versatility and visual appeal, such as a melamine decorative top or a cushion pad.

Dankzij het ruime kleurenaanbod en de verschillende afwerkingen kan ARMAND aan elke stijlvoorkeur worden aangepast. Naargelang uw opbergbehoeften voegt u metalen of melamine legborden toe. Voor mappen is er een telescopisch hangframe. ARMAND opbergmeubilair kan ook aangevuld worden met praktische en elegante accessoires zoals het melamine topblad of het zitkussen.



# OPTIONS OPTIONS OPTIES



Tablette métal ou mélamine  
Metal or melamine shelf  
Metalen of melamine legbord



Coussin d'assise tissu pour armoire mélamine  
portes coulissantes (meuble bas)  
Fabric cushion pad for melamine cupboard  
with sliding doors (low storage modules)  
Stoffen zitkussen voor melamine kast met  
schuifdeuren (laag meubel)



Châssis télescopique  
Telescopic cradle  
Telescopisch hangframe

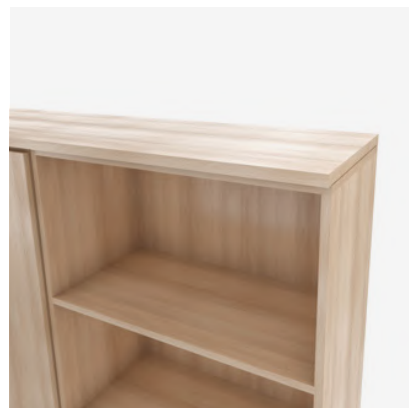

Top de finition mélamine  
Melamine decorative top  
Melamine topblad

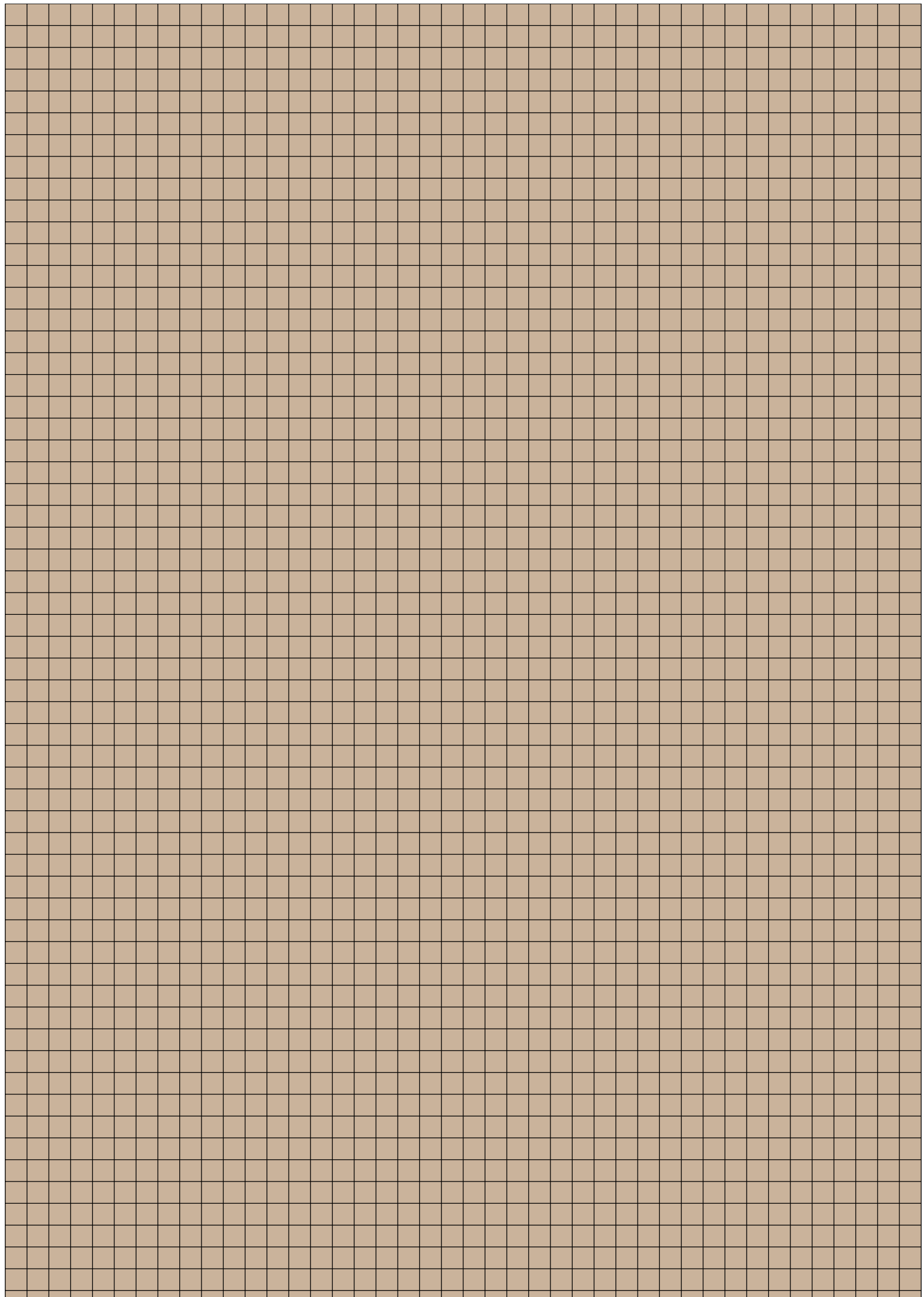

**SYNTHÈSE**  
—  
**SUMMARY**  
**OVERZICHT**

**GAMME  
RANGE  
COLLECTIE**



Armoires 2 portes battantes mélamine  
Cupboards with 2 melamine swing doors  
Kasten met 2 melamine draaideuren



Armoires 2 portes battantes verre  
Cupboards with 2 glass swing doors  
Kasten met 2 glazen draaideuren



Armoires 2 portes coulissantes mélamine  
Cupboards with 2 melamine sliding doors  
Kasten met 2 melamine schuifdeuren



Bibliothèques sans portes  
Open bookcases without doors  
Boekenkasten zonder deuren



Bibliothèques semi-ouvertes avec portes mélamine ou verre  
Semi-open bookcases featuring melamine or glass doors  
Halfopen boekenkasten met melamine of glazen deuren



Armoires 4 portes battantes mélamine et/ou verre  
Cupboards with 4 melamine and/or glass swing doors  
Kasten met 4 melamine en/of glazen draaideuren



Meubles séparateurs d'espace 2 portes mélamine + 2 portes Altuglas®  
 Partitioning units with 2 melamine doors + 2 Altuglas® doors  
 Meubelen voor ruimte-indeling met 2 melamine deuren + 2 Altuglas® deuren



Penderie 2 portes mélamine  
 Wardrobe with 2 melamine doors  
 Garderobekast met 2 melamine deuren



Classeurs à tiroirs  
 Drawer credenzas  
 Archiefladekasten



Meuble réfrigérateur  
 Refrigerated unit  
 Koelkast



Module bas 2 portes Altuglas®  
 Low storage module with 2 Altuglas® doors  
 Lage module met 2 Altuglas® deuren

# SYNOPTIQUE OVERVIEW OVERZICHT

Armoire 2 portes battantes - Cupboard with 2 swing doors - Kast met 2 draaideuren

---

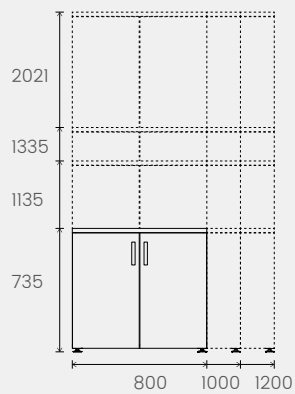

Armoire 2 portes coulissantes - Cupboard with 2 sliding doors - Kast met 2 schuifdeuren

---

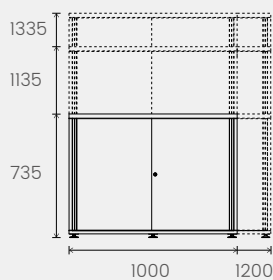

Bibliothèque - Bookcase - Boekenkast

---

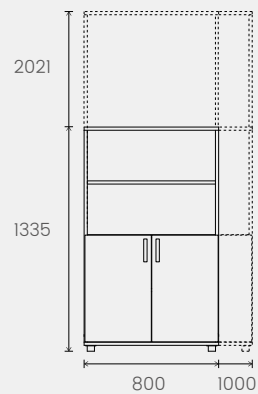
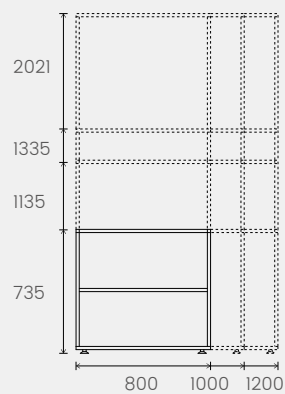

Armoire 4 portes battantes - Cupboard with 4 swing doors - Kast met 4 draaideuren

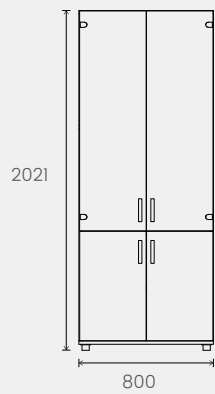

Meuble séparateur d'espace - Partitioning unit - Meubel voor ruimte-indeling

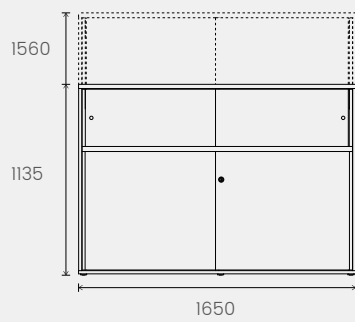

Penderie - Wardrobe unit - Garderobekast

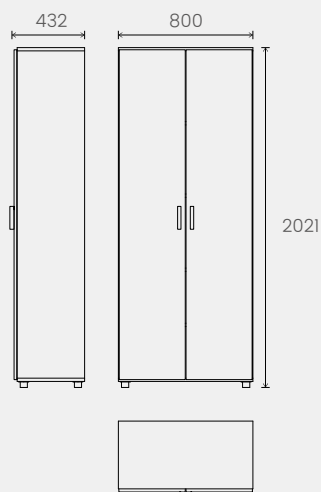

Classeur à tiroirs - Drawer credenza - Archiefladekast

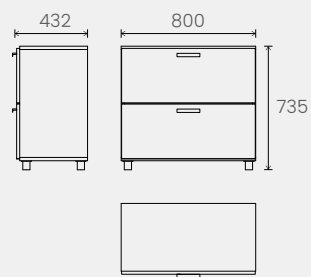

Meuble réfrigérateur - Refrigerated unit - Koelkast

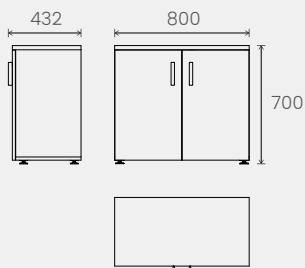

Module bas - Low storage module - Lage module

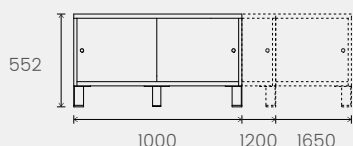

Options pour armoire portes battantes et bibliothèque - Options for swing door cupboard and bookcase units - Opties voor draaideurkast en boekenkast

Tablette mélamine - Melamine shelf - Melamine legbord

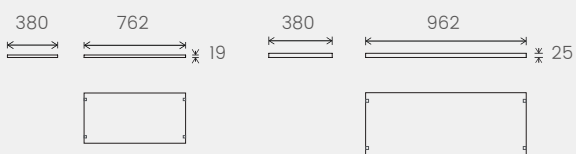

Tablette métal pour dossiers suspendus - Metal shelf for suspension files - Metalen legbord voor hangmappen



Options pour armoire portes coulissantes - Options for cupboard with sliding doors - Opties voor schuifdeurkast

Tablette mélamine - Melamine shelf - Melamine legbord



Tablette métal pour dossiers suspendus - Metal shelf for suspension files - Metalen legbord voor hangmappen

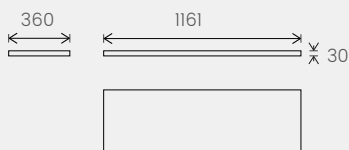



## Coussin d'assise - Cushion pad - Zitkussen

---

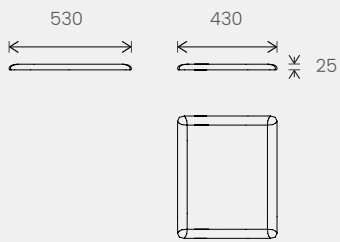

## Top de finition mélamine - Melamine decorative top - Melamine topblad

---

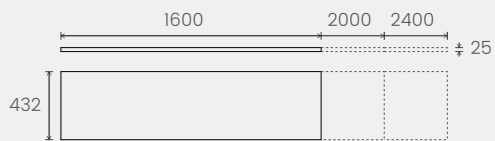

## Châssis télescopique - Telescopic cradle - Telescopisch hangframe

---

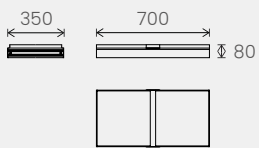

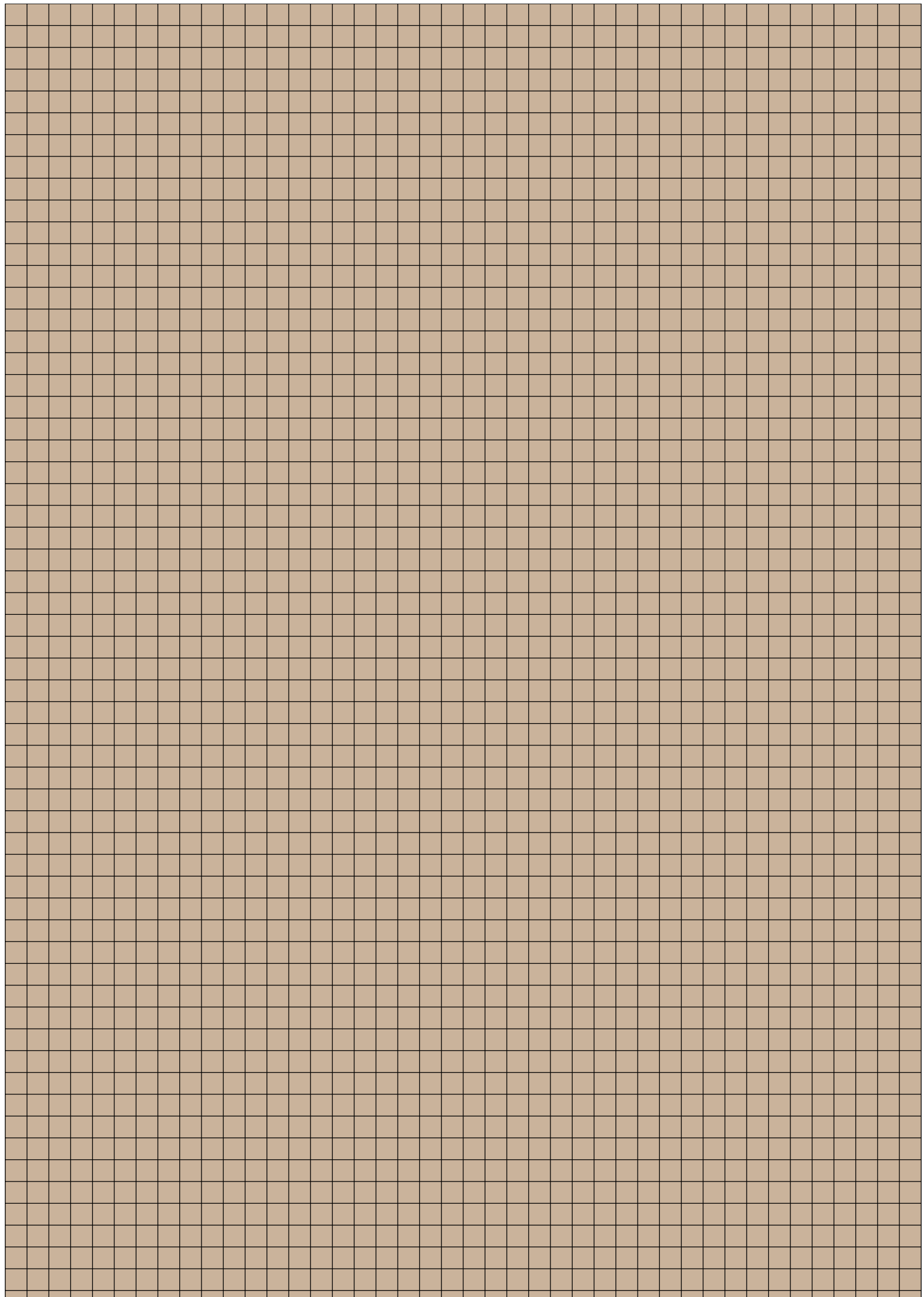













**MATIÈRES** & COULEURS

—



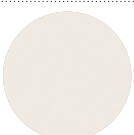
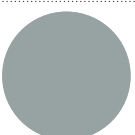
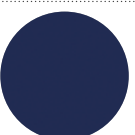
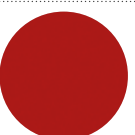
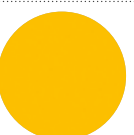
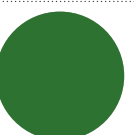

**MATERIALS** & COLOURS

**MATERIALEN** & KLEUREN

1. MÉLAMINE (corps, tablette, façade & top (pour H.73,5)) – MELAMINE (carcass, shelf, shade & top (for H.73,5)) – MELAMINE (ombouw, legbord, ladefront & topblad (voor H. 73,5))

 MU   Gris aluminium <sup>(3)</sup> Aluminium grey <sup>(3)</sup> Alugrijs <sup>(3)</sup>	 MG   Blanc neige Snow white Sneeuw wit	 M6   Gris cachemire Cashmere grey Kasjmier grijs	 RI   Chêne clair Light oak Licht eiken	STOCK <sup>(1)</sup>	 MA   Érable blanc White maple Wit esdoorn	 R2   Hêtre de Honfleur Honfleur beech Beuk van Honfleur	DÉLAI <sup>(2)</sup>
 R3   Chêne Brunswick <sup>(4)</sup> Brunswick oak <sup>(4)</sup> Brunswick eiken <sup>(4)</sup>	 RL   Noyer ambré Amber walnut Amber notenhout	 MT   Chêne royal brun Royal brown oak Royal bruin eiken	 M8   Chêne gris Grey oak Grijs eiken	DÉLAI <sup>(2)</sup>	 RZ   Acacia de Lakeland Lakeland acacia Lakeland acacia	 R4   Merisier ambré Amber cherry Honing kersenhout	+5% DÉLAI <sup>(2)</sup>
 M5   Gris brume Mist grey Nevel grijs	 M7   Vert fjord Fjord green Fjord groen	 M3   Bleu nuit Midnight blue Nacht blauw	 M1   Rouge cerise <sup>(5)</sup> Cherry red <sup>(5)</sup> Kers rood <sup>(5)</sup>	DÉLAI <sup>(2)</sup>	 M4   Jaune tournesol Sunflower yellow Zonnebloem geel	 M2   Vert fougère Fern green Varen groen	+5% DÉLAI <sup>(2)</sup>

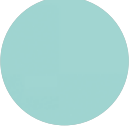
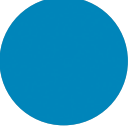
2. ALTUGLAS® (portes) – ALTUGLAS® (doors) – ALTUGLAS® (deuren)

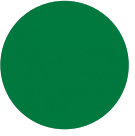
 OA   Blanc White Wit	 OB   Gris fumé Smoked grey Rookgrijs	STOCK <sup>(1)</sup>	 O3   Vert d'eau satin Satin watercolour green Satijn water groen	 O2   Bleu satin Satin blue Satijn blauw	DÉLAI <sup>(2)</sup>	+5%
 OX   Rouge satin Satin red Satijn rood	 O4   Jaune satin Satin yellow Satijn geel	 O1   Vert satin Satin green Satijn groen	DÉLAI <sup>(2)</sup>	+5%		

<sup>(3)</sup> La finition Gris aluminium (MU) n'est pas disponible sur stock pour les façades – <sup>(3)</sup> The shades are not available from stock in Grey aluminium (MU) finish – <sup>(3)</sup> Kleur Alugrijs niet uit voorraad leverbaar voor de fronten

<sup>(4)</sup> La finition Chêne Brunswick (R3) n'est pas disponible sur stock pour le corps – <sup>(4)</sup> The carcass are not available from stock in Brunswick oak (R3) finish – <sup>(4)</sup> Kleur Brunswick eiken niet uit voorraad leverbaar voor de ombouw.

<sup>(5)</sup> Coloris uniquement en stock pour les portes coulissantes Largeur 1200 mm – <sup>(5)</sup> Colours from stock only for sliding door versions Width 1200 mm – <sup>(5)</sup> Kleur uit voorraad voor de schuifdeuren Breedte 1200 mm

**+5%** Majoration de 5% sur le PPHT indiqué  
5 percent mark-up on the RRP excl. tax  
Meerprijs van 5% op de opgegeven verkoopprijs excl. BTW

<sup>(1)</sup> STOCK / STOCK / VOORRAAD

<sup>(2)</sup> DÉLAI / ON REQUEST / MET LEVERTIJD

### 3. VERRE (portes) – GLASS (doors) – GLAS (deuren)

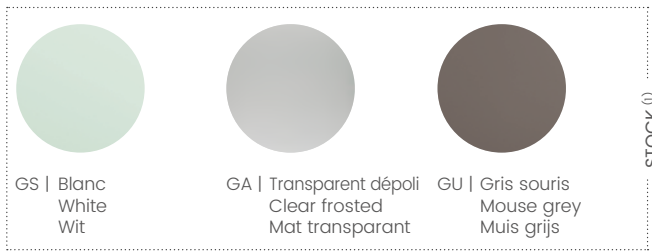

### 4. METAL (tablette) – METAL (shelf) – METAAL (legbord)

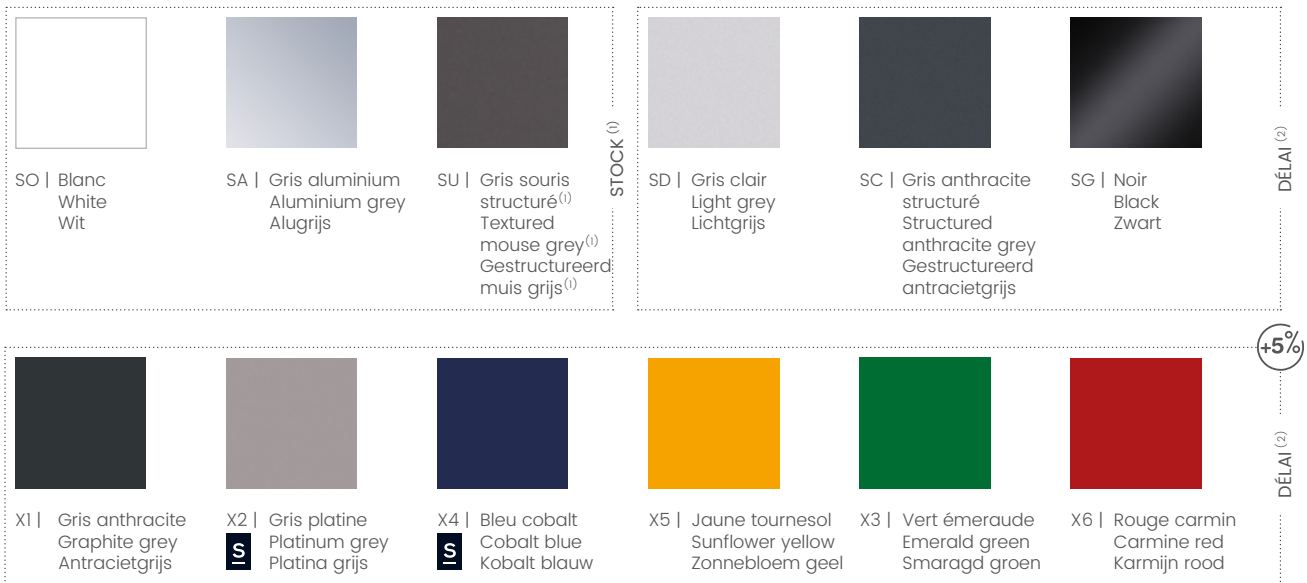

### 5. TISSUS (placet d'assise) – FABRICS (cushion pad) – STOFFEN (zitkussen)













#### Bondai (100% polyester) – Cat A











**+5%** Majoration de 5% sur le PPHT indiqué  
5 percent mark-up on the RRP excl. tax  
Meerprijs van 5% op de opgegeven verkoopprijs excl. BTW

<sup>(1)</sup> STOCK / STOCK / VOORRAAD  
<sup>(2)</sup> DÉLAI / ON REQUEST / MET LEVERTIJD

## Xtreme CS (100% polyester) - Cat B

			STOCK <sup>(1)</sup>				DÉLAI <sup>(2)</sup>
U4   Gris clair Light grey Lichtgrijs	V6   Jaune safran Saffron yellow Saffraan	W5   Vert brun Green brown Bruingrijs		W3   Gris beige Beige grey Beige grijs	W4   Brun Brown Bruin	W6   Bleu nuit Night blue Nachtblauw	
						DÉLAI <sup>(2)</sup>	
U5   Noir Black Zwart	W1   Vert canard Duck green Vedergroen	W2   Vert impérial Imperial green Keizergroen	V8   Vert printemps Spring green Lente groen	V1   Bleu égyptien Egyptian blue Egyptisch blauw	U1   Rouge vermillon Vermillion red Vermiljoen rood		
							
U2   Prune Plum Pruim							

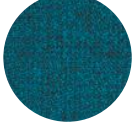
## Step (100% Trevira) - Cat B

						DÉLAI <sup>(2)</sup>
A1   Bamboo Bamboo Bamboe	A2   Beige Beige Beige	A3   Bleu marine Navy blue Marine blauw	A4   Bleu pétrole Petroleum blue Petroleum blauw	A5   Jaune moutarde Mustard yellow Mosterd geel	A6   Noir Black Zwart	
						
A7   Rouge cardinal Cardinal red Kardinaal rood	A8   Turquoise Turquoise Turquoise	A9   Vert anglais English green Engels groen				



Majoration de 5% sur le PPHT indiqué  
5 percent mark-up on the RRP excl. tax  
Meerprijs van 5% op de opgegeven verkoopprijs excl. BTW

<sup>(1)</sup> STOCK / STOCK / VOORRAAD

<sup>(2)</sup> DÉLAI / ON REQUEST / MET LEVERTIJD

## Step mélange (100% Trevira) - Cat B

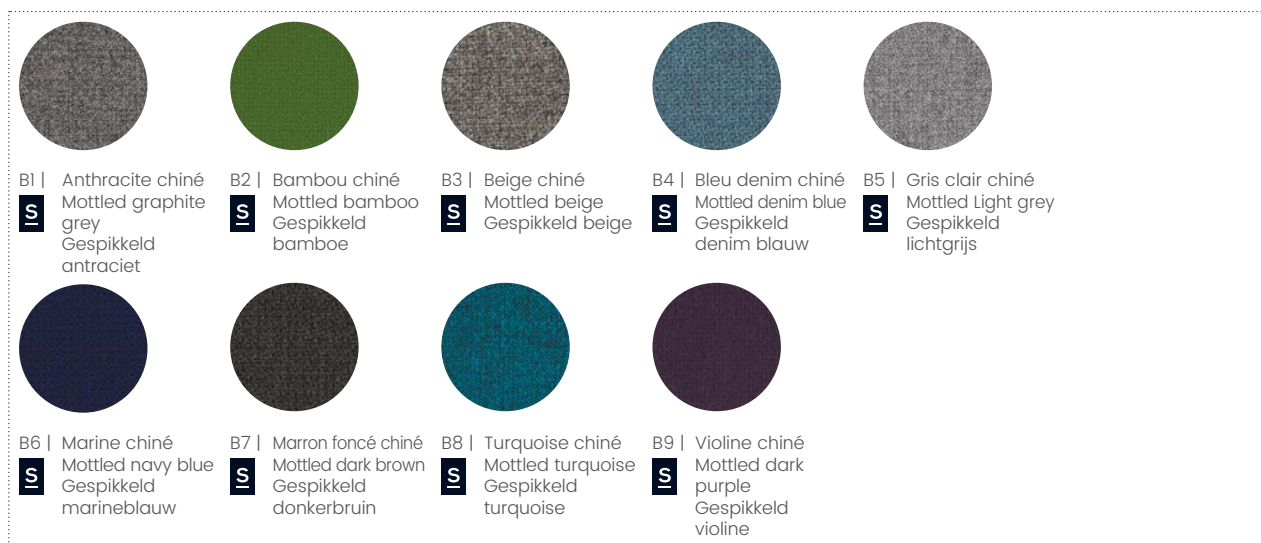

DÉLAI<sup>(2)</sup>

## Ginkgo (85% PVC / 15% coton - cotton - katoen) - Cat C

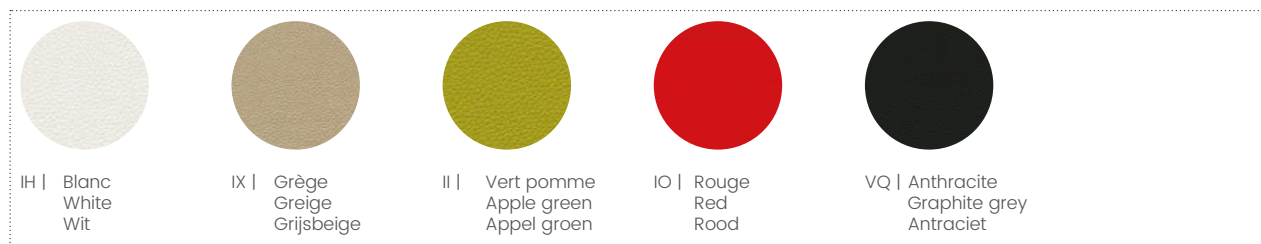

DÉLAI<sup>(2)</sup>

## Blazer (100% laine vierge - virgin wool - scheerwol) - Cat D

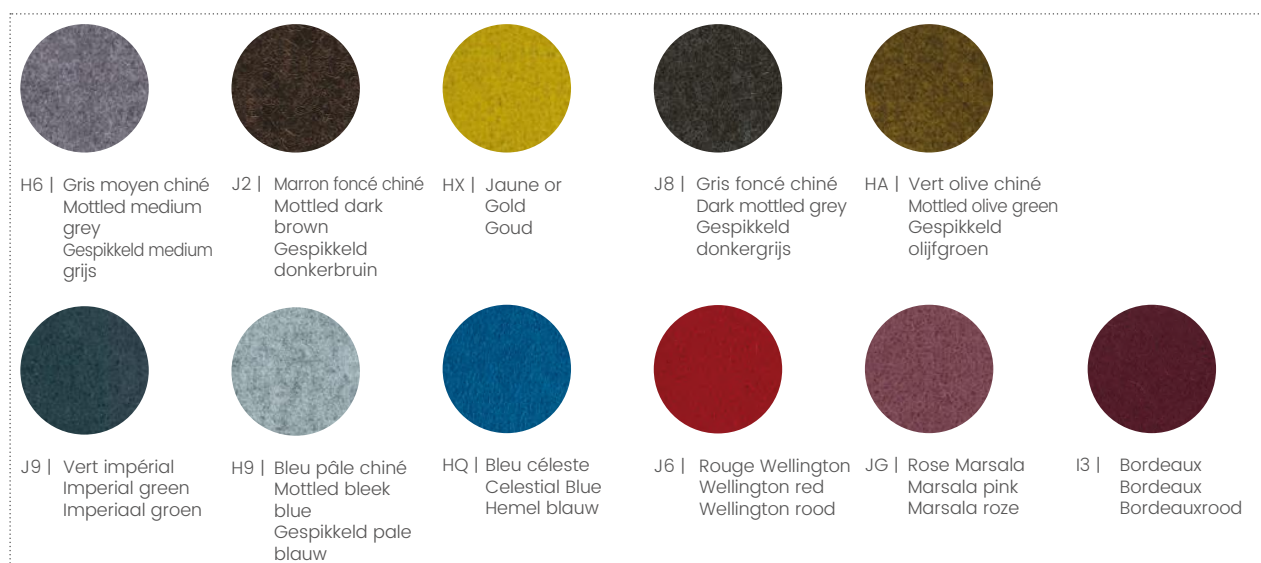

DÉLAI<sup>(2)</sup>

**S** Exclusivité / Exclusive to / Exclusiviteit  
SIGNATURE BY EOL

<sup>(1)</sup> STOCK / STOCK / VOORRAAD

<sup>(2)</sup> DÉLAI / ON REQUEST / MET LEVERTIJD

**CAISSON MÉTAL**  
—  
**METAL PEDESTALS**  
**METALEN LADEBLOK**



**Signature**  
— BY EOL —





## PRATIQUES & COLORÉS

**L**es caissons, compléments indispensables au poste de travail, existent en version mobile ou hauteur bureau. Ils offrent un espace de rangement pratique et accessible, à proximité du bureau. Disponibles en plusieurs dimensions et nombreux coloris, les caissons métal s'adaptent à tous types de configurations et offrent un grand choix de personnalisation. Fabriqués en Europe, ces caissons se caractérisent par des finitions soignées et une structure robuste.

---

## PRACTICAL & COLOURFUL

**I**ndispensable components to any workstation, our pedestals are available in mobile and desk height versions. They offer a practical and easy to reach storage space, right by the desk. Available in several sizes and colours, our metal pedestals easily fit in to a variety of desking configurations and are highly customisable. Made in Europe, these pedestals stand out through their high-quality finishes and sturdy construction.

---

## PRAKTISCH & KLEURRIJK

**L**adeblokken zijn uiteraard niet weg te denken uit de kantooromgeving. Ze bestaan in verrijdbare versie of op bureauhoogte, bieden praktische opbergruimte binnen handbereik en zijn leverbaar in verschillende afmetingen en kleuren. Onze personaliseerbare metalen ladeblokken kunnen in elke kantoorstijl geïntegreerd worden. Ze worden vervaardigd in Europa en vallen op met hun onberispelijke en robuuste afwerking.

---

**À CHACUN SON RANGEMENT**  
**STORAGE ADAPTED TO EVERY NEED**  
**PERSOONLIJK OPBERGRUIMTE**



En version standard mobile, le caisson métal peut être déplacé facilement et peut ainsi servir d'assise d'appoint grâce à son coussin adapté vendu en option.

The standard mobile metal pedestal version is easy to move around and can double up as a useful seat, by the simple addition of a cushion pad sold separately.

In de verrijdbare standaarduitvoering kan het ladeblok makkelijk verplaatst worden en met het optionele kussen biedt het zelfs een extra zitplaats aan het bureau.



Astucieux et pratique, le caisson mobile faible encombrement est idéal pour des espaces réduits, tout en conservant une capacité de rangement satisfaisante.

Clever and practical, our compact mobile pedestal is perfect for smaller spaces, yet still provides ample storage capacity.

Het plaatsbesparende verrijdbare ladeblok is ideaal voor kleine ruimtes, maar biedt toch slimme en praktische opbergmogelijkheden.



En version hauteur bureau, le caisson peut s'intégrer directement sous le plateau et devient alors un élément structurel du bureau.

The desk height pedestal version can be placed directly underneath the worktop, providing structural support to the desk.

In de versie op bureauhoogte wordt het ladeblok onder het blad een structureel onderdeel van het bureau.



En version hauteur bureau, le caisson peut aussi se placer à côté du poste de travail et devenir une véritable extension permettant de gagner en surface de travail.

A desk height pedestal can also be positioned alongside the workstation, creating a desk extension and providing a useful additional worksurface.

In de versie op bureauhoogte kan het ladeblok ook naast het bureau worden geplaatst en biedt het extra werkruimte.



Roulettes dissimulées (uniquement pour caisson mobile)  
Concealed castors (mobile pedestal only)  
Onzichtbare wielen (op de verrijdbare versie)



Préhension latérale  
Lateral grip handles  
Laterale handgrepen



Plumier intégré  
Integrated pen tray  
Geïntegreerde pennenlade

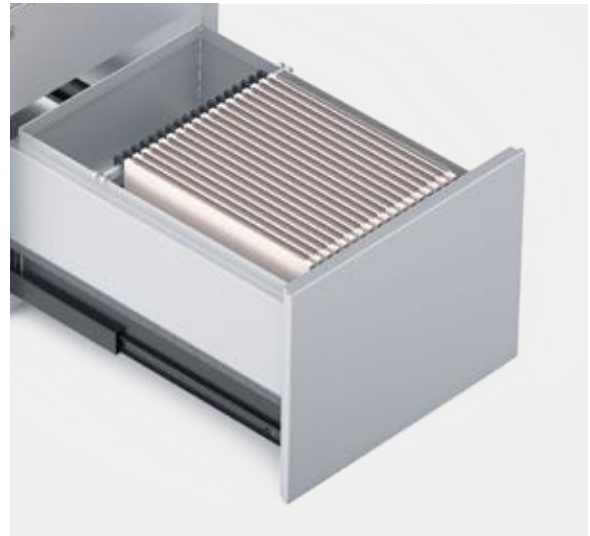

Tiroir DS extractible à 100%  
Fully extractable suspension file drawer  
Hangmappenlade 100% uittrekbaar

**PERSONNALISER LE CAISSON MÉTAL**  
**CUSTOMISE METAL PEDESTALS**  
UW METALEN LADEBLOK **PERSONALISEREN**



Au-delà de leur fonction de rangement, les caissons métal disposent de plusieurs accessoires optionnels permettant de gagner en praticité & ergonomie : coussin d'assise, top mélamine, réhausse de rangement...

Beyond the mere storage functionality, metal pedestals can also receive optional accessories that will further enhance the practical and ergonomic aspects of their design: cushion pads, melamine top, supplemental storage units...

De metalen ladeblokken zijn meer dan opbergruimte alleen. Met hun optionele accessoires worden ze een praktisch en ergonomisch onderdeel van uw werkomgeving: zitkussen, melamine topblad, opzetmodule...



Coussin d'assise en tissu  
Fabric cushion pad  
Stoffen zitkussen



Top de finition en mélamine pour caisson mobile  
Melamine decorative top for mobile pedestals  
Melamine topblad voor verrijdbare ladeblokken



Réhausse de rangement bureau  
Supplemental desktop storage unit  
Opzetmodule



Kit de 8 entretoises pour rehausser le caisson hauteur bureau  
Kit comprising 8 spacers for raising desk height pedestals  
Set van 8 ophoogblokjes voor het ladeblok op bureauhoogte



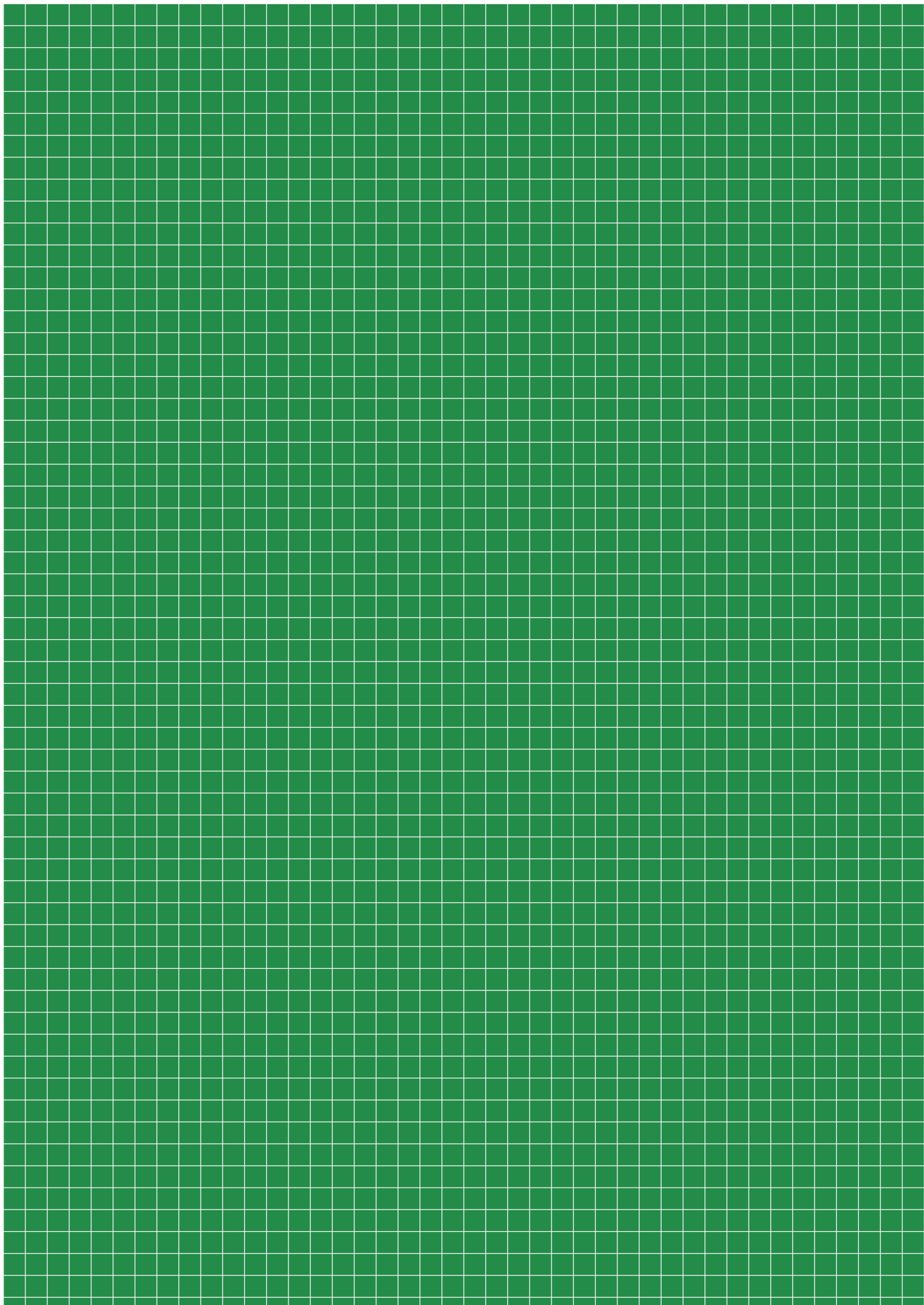

**SYNTHESE, DIMENSIONS & COULEURS**

—

**SUMMARY, DIMENSIONS & COLOURS**  
**OVERZICHT, AFMETINGEN & KLEUREN**

# GAMME RANGE COLLECTIE

Caissons mobiles – Mobile pedestals – Verrijdbare ladeblokken

2 tiroirs dont 1 DS\* – 2 box drawer + 1 suspension file drawer – 2 laden waarvan 1 hangmappenlade



Top métal  
Metal top  
Metalen topblad



Top mélamine  
Melamine top  
Melamine topblad



Caisson avec tirette plumier  
Drawer with pencil tray  
Ladeblok met pennenlade

3 tiroirs – 3 drawers – 3 laden



Top métal  
Metal top  
Metalen topblad



Top mélamine  
Melamine top  
Melamine topblad



Caisson avec tirette plumier  
Drawer with pencil tray  
Ladeblok met pennenlade

Caissons mobiles faible encombrement – Compact mobile pedestals – Plaatsbesparende ladeblokken



2 tiroirs dont 1 DS, top métal  
2 box drawer + 1 suspension file drawer,  
metal top  
2 laden waarvan 1 hangmappenlade,  
metalen topblad



3 tiroirs, top métal  
3 drawers, metal top  
3 laden, metalen topblad

## Caissons hauteur bureau - Desk height pedestals - Ladeblokken op bureauhoogte

3 tiroirs dont 1 DS - 3 box drawers + 1 suspension file drawer - 3 laden waarvan 1 hangmappenlade



Prof. 600 mm, top mélamine  
Depth 600 mm, melamine top  
Diepte 600 mm, melamine topblad



Prof. 800 mm, sans top  
Depth 800 mm, no decorative top  
Diepte 800 mm, zonder topblad



Prof. 800 mm, top mélamine  
Depth 800 mm, melamine top  
Diepte 800 mm, melamine topblad

4 tiroirs - 4 drawers - 4 laden



Prof. 600 mm, top mélamine  
Depth 600 mm, melamine top  
Diepte 600 mm, melamine topblad



Prof. 800 mm, sans top  
Depth 800 mm, no decorative top  
Diepte 800 mm, zonder topblad



Prof. 800 mm, top mélamine  
Depth 800 mm, melamine top  
Diepte 800 mm, melamine topblad

# SYNOPTIQUE

## OVERVIEW

## OVERZICHT

Caissons mobiles - Mobile pedestals - Verrijdbare ladeblokken

2 tiroirs dont 1 DS\* - 2 box drawer + 1 suspension file drawer - 2 laden waarvan 1 hangmappenlade

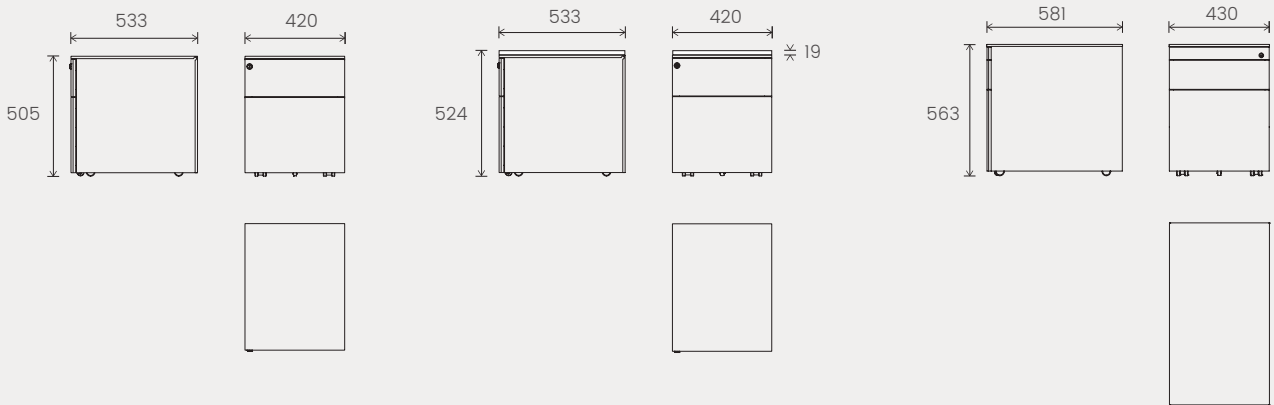

3 tiroirs - 3 drawers - 3 laden

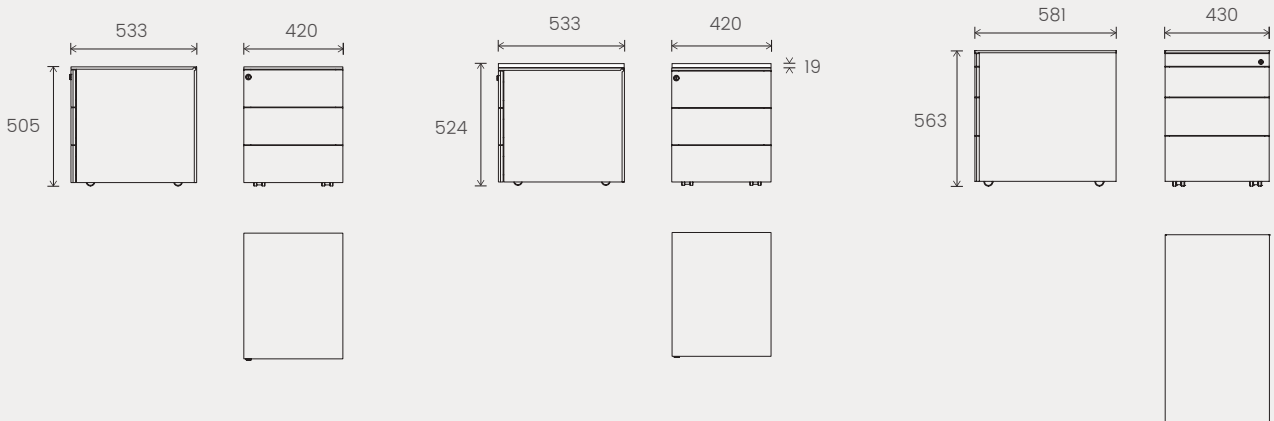

Caissons mobiles faible encombrement - Compact mobile pedestals - Plaatsbesparende ladeblokken

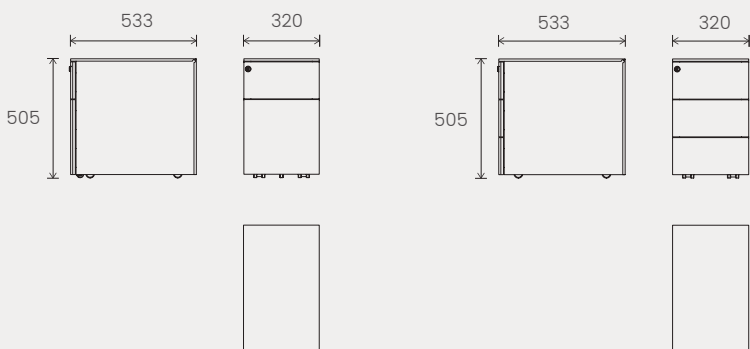

Caissons hauteur bureau - Desk height pedestals - Ladeblokken op bureauhoogte

3 tiroirs dont 1 DS - 3 box drawers + 1 suspension file drawer - 3 laden waarvan 1 hangmappenlade

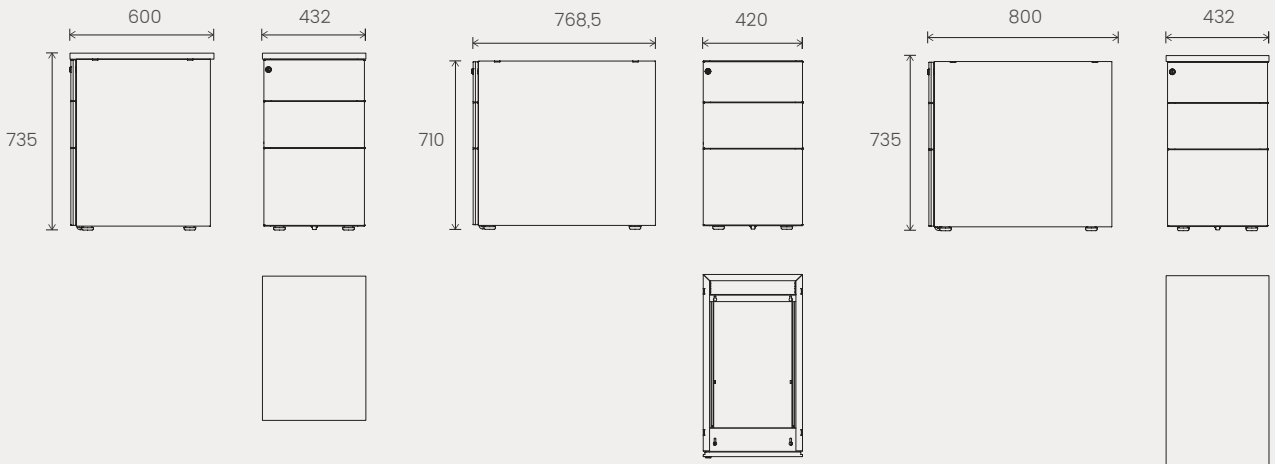



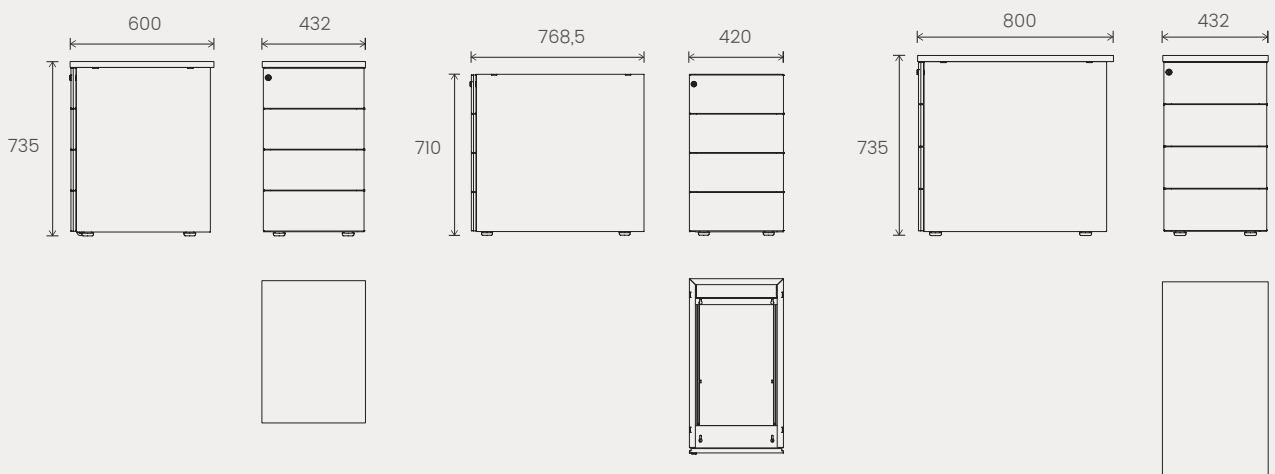



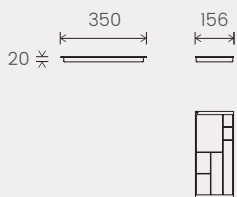

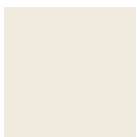

4 tiroirs - 4 drawers - 4 laden

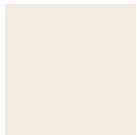

Plumier - Pen tray - Pennenlade



## 1. METAL (caisson) – METAL (pedestal) – METAAL (ladeblok)

<p>Uniquement pour caissons vendus à l'unité / Pedestals sold individually only/ Alleen ladeblokken per stuk verkocht</p>					<p>STOCK <sup>(1)</sup></p>	
	SO   Blanc lisse White Wit	SB   Gris aluminium Aluminium grey Alugrijs	SC   Gris anthracite structuré Textured graphite grey Gestructureerd antraciet	SG   Noir Black Noir		
<p>Uniquement pour caissons vendus par lot de 8 ou 12 / Pedestals sold in sets of 8 or 12 only/ Alleen ladeblokken per sets van 8 of 12 verkocht</p>					<p>+5%</p> <p>DÉLAI <sup>(2)</sup></p>	
	ZO   Blanc structuré Textured white Gestructureerd wit	SD   Gris clair Light grey Lichtgrijs	SI   Aluminium gris foncé Dark grey aluminium Donkergrijs aluminium	SN   Bleu saphir Sapphire blue Saffierblauw		SS   Jaune colza Rape yellow Raapzaad geel
						
	X3   Vert émeraude Emerald green Smaragd groen	SR   Rouge Traffic Traffic red Rood verkeer				

## 2. MELAMINE (top caisson mobile ép.19 mm & top caisson hauteur bureau ép. 25 mm) – MELAMINE (mobile pedestal top 19 mm thick & desk height pedestal top 25 mm thick) – MELAMINE (topblad voor verrijdbaar ladeblok, dikte 19 mm & topblad voor ladeblok op bureauhoogte, dikte 25 mm)

						<p>STOCK <sup>(1)</sup></p>
MG   Blanc neige Snow white Sneeuw wit	M6   Gris cachemire Cashmere grey Kasjmier grijs	MA   Érable blanc White maple Wit esdoorn	R2   Hêtre de Honfleur Honfleur beech Beuk van honfleur	RI   Chêne clair Light oak Licht eiken	R3   Chêne Brunswick Brunswick oak Brunswick eik	
						<p>+5%</p> <p>DÉLAI <sup>(2)</sup></p>
RL   Noyer ambré Amber walnut Amber notenhout	MT   Chêne royal brun Royal brown oak Royal bruin eiken					
						
M5   Gris brume Mist grey Nevel grijs	M7   Vert fjord Fjord green Fjord groen	M3   Bleu nuit <sup>(3)</sup> Midnight blue Nacht blauw	M1   Rouge cerise <sup>(3)</sup> Cherry red Kers rood	M4   Jaune tournesol <sup>(3)</sup> Sunflower yellow Zonnebloem geel	M2   Vert fougère <sup>(3)</sup> Fern green Varen groen	
						
M8   Chêne gris Grey oak Grijs eiken	RZ   Acacia de Lakeland Lakeland acacia Lakeland acacia					

+5% majoration de 5% sur le PP HT indiqué  
5% mark-up on the RRP excl. tax  
meerprijs van 5% op de opgegeven verkopprijs excl. BTW

<sup>(1)</sup> STOCK / STOCK / VOORRAAD  
<sup>(2)</sup> DÉLAI / ON REQUEST / MET LEVERTIJD  
<sup>(3)</sup> UNIQUEMENT POUR CAISSONS MOBILES / MOBILE PEDESTALS ONLY / ALLEEN VOOR VERRIJDABARE LADEBLOKKEN

**S** Exclusivité / Exclusive to / Exclusiviteit  
SIGNATURE BY EOL

3. MELAMINE (Réhausse de rangement pour caisson hauteur bureau Prof. 800 mm) - MELAMINE (supplemental storage unit for desk height pedestal, Depth 800 mm) - MELAMINE (Opzetmodule voor ladeblok op bureauhoogte, diepte 800 mm)

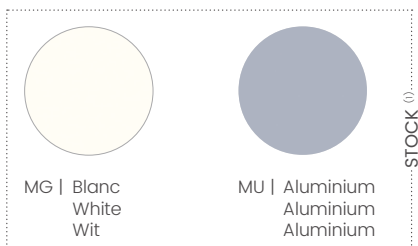

4. MÉTAL (réhausse de rangement pour caisson hauteur bureau Prof. 800 mm) - METAL (supplemental storage unit for desk height pedestal, Depth 800 mm) - MÉTAAL (opzetmodule voor ladeblok op bureauhoogte, diepte 800 mm)

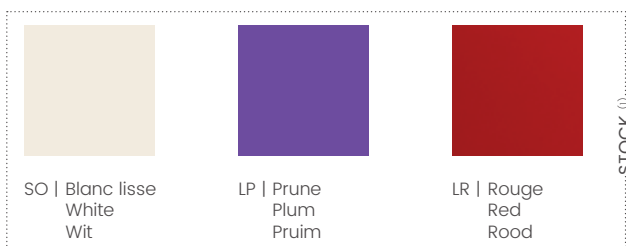

5. TISSUS (Coussin d'assise) - FABRICS (Cushion pad) - STOFFEN (Stoffen zitkussen)



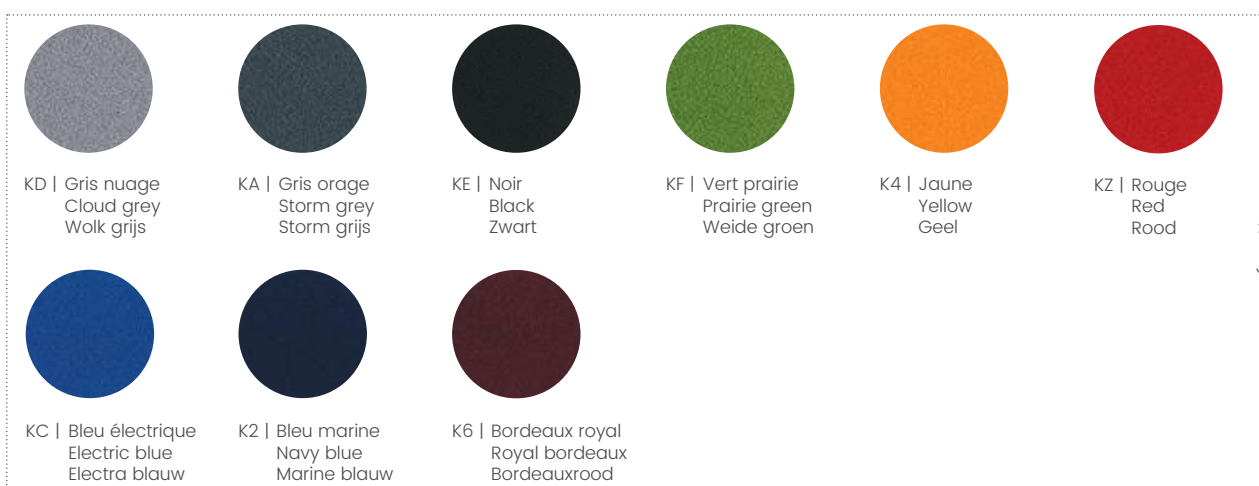





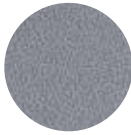

**Bondai** (100% polyester) - Cat A





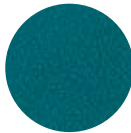
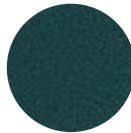











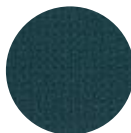
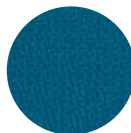

<sup>(1)</sup> STOCK / STOCK / VOORRAAD  
<sup>(2)</sup> DÉLAI / ON REQUEST / MET LEVERTIJD



## Xtreme CS (100% polyester) - Cat B

			STOCK <sup>(1)</sup>		
U4   Gris clair Light grey Lichtgrijs	W5   Vert brun Green brown Bruingrijs	W6   Jaune safran Saffron yellow Saffraan			
					
U5   Noir Black Zwart	W3   Gris beige Beige grey Beige grijs	W4   Brun Brown Bruin	V8   Vert printemps Spring green Lente groen	W1   Vert canard Duck green Vedergroen	W2   Vert impérial Imperial green Keizergroen
				DÉLAI <sup>(2)</sup>	
U1   Rouge vermillon Vermillion red Vermiljoen rood	V1   Bleu égyptien Egyptian blue Egyptisch blauw	W6   Bleu nuit Night blue Nachtblauw	U2   Prune Plum Pruim		

## Step (100% Trevira CS) - Cat B

						+5%
A2   Beige  Beige Beige	A6   Noir  Black Zwart	A9   Vert anglais  English green Engels groen	A1   Bambou  Bamboo Bamboo Bamboe	A4   Bleu pétrole  Petroleum blue Petroleum blauw	A8   Turquoise  Turquoise Turquoise	
			DÉLAI <sup>(2)</sup>			
A3   Bleu marine  Navy blue Marine blauw	A5   Jaune moutarde  Mustard yellow Mosterd geel	A7   Rouge cardinal  Cardinal red Kardinaal rood				

**+5%** majoration de 5% sur le PP HT indiqué  
5% mark-up on the RRP excl. tax  
meerprijs van 5% op de opgegeven verkopprijs excl. BTW

<sup>(1)</sup> STOCK / STOCK / VOORRAAD  
<sup>(2)</sup> DÉLAI / ON REQUEST / MET LEVERTIJD

 Exclusivité / Exclusive to / Exclusiviteit  
SIGNATURE BY EOL

## Step mélange (100% Trevira CS) - Cat B

+5%

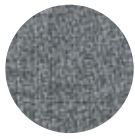

B5 | Gris clair chiné  
Mottled Light grey  
Gespikkeld lichtgrijs

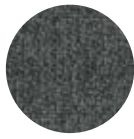

B1 | Anthracite chiné  
Mottled graphite grey  
Gespikkeld antraciet

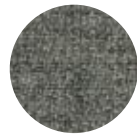

B3 | Beige chiné  
Mottled beige  
Gespikkeld beige

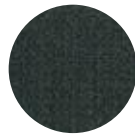

B7 | Marron foncé chiné  
Mottled dark brown  
Gespikkeld donkerbruin



B2 | Bambou chiné  
Mottled bamboo  
Gespikkeld bamboe



B4 | Bleu denim chiné  
Mottled denim blue  
Gespikkeld denim blauw



B8 | Turquoise chiné  
Mottled turquoise  
Gespikkeld turquoise



B9 | Violette chiné  
Mottled dark purple  
Gespikkeld violette

DÉLAI (2)

## Ginkgo (85% PVC / 15% coton - cotton - katoen) - Cat C



IH | Blanc  
White  
Wit



IX | Grège  
Greige  
Grijsbeige



VQ | Anthracite  
Graphite grey  
Antraciet



II | Vert pomme  
Apple green  
Appel groen



IO | Rouge  
Red  
Rood

DÉLAI (2)

## Blazer (100% laine vierge - virgin wool - scheerwol) - Cat D

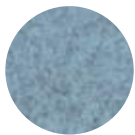

H9 | Bleu pâle chiné  
Mottled bleek blue  
Gespikkeld pale blauw

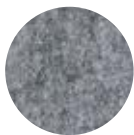

H6 | Gris moyen chiné  
Mottled medium grey  
Gespikkeld medium grijs



J8 | Gris foncé chiné  
Dark mottled grey  
Gespikkeld donkergrijs



J2 | Marron foncé chiné  
Mottled dark brown  
Gespikkeld donkerbruin



HA | Vert olive chiné  
Mottled olive green  
Gespikkeld olijfgroen



J6 | Rouge Wellington  
Wellington red  
Wellington rood



HX | Jaune or  
Gold  
Goud



J9 | Vert impérial  
Imperial green  
Imperial groen



HQ | Bleu céleste  
Celestial Blue  
Hemel blauw



I3 | Bordeaux  
Bordeaux  
Bordeauxrood



JG | Rose Marsala  
Marsala pink  
Marsala roze

DÉLAI (2)

# CAMILLE

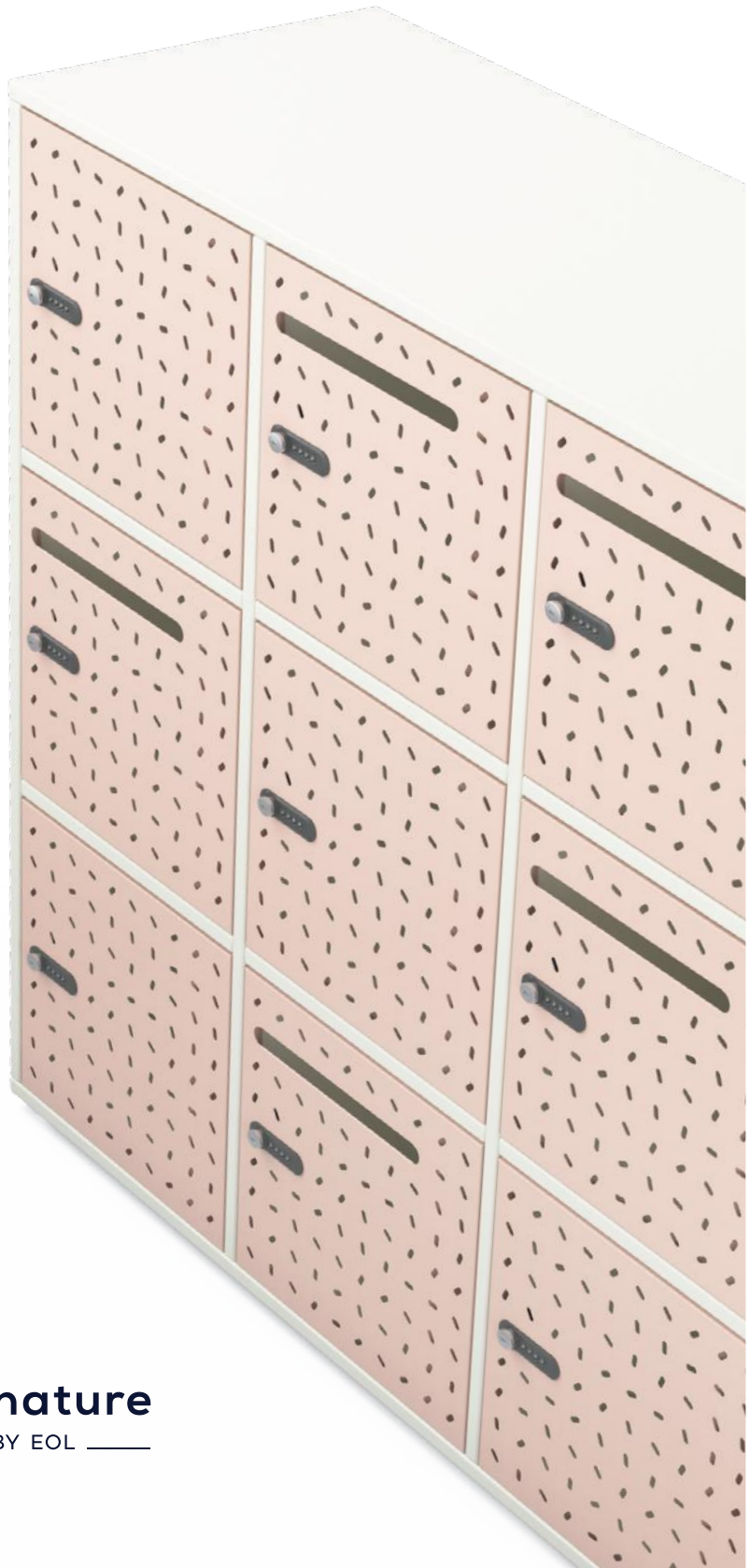

**Signature**  
— BY EOL —

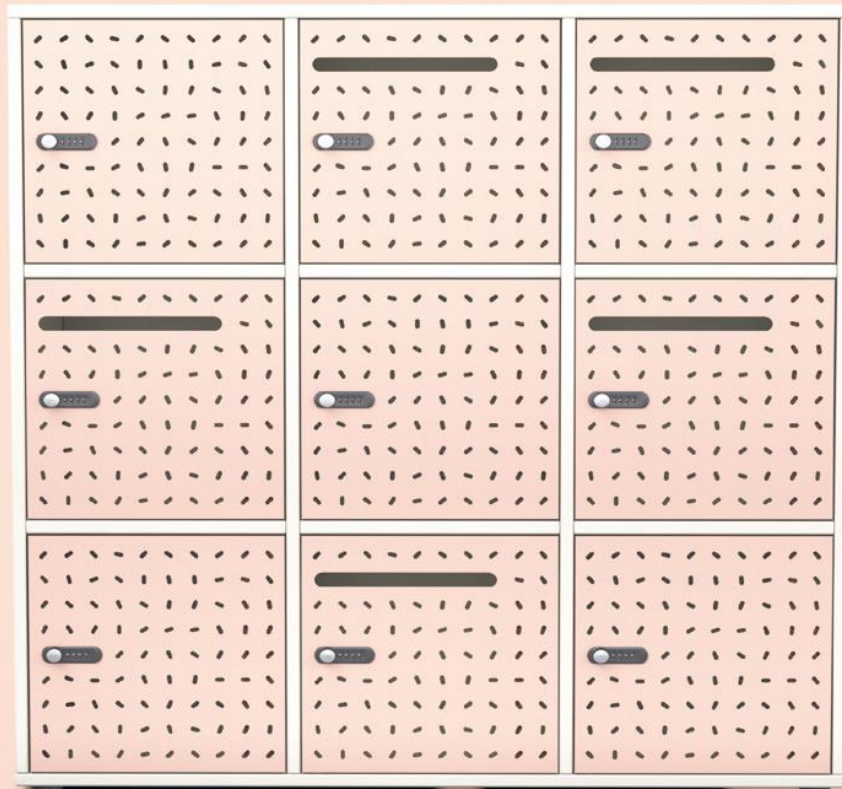

## SÉCURISÉ & PERSONNALISABLE

**S**'inscrivant pleinement dans la tendance du flex-office, CAMILLE est un meuble fonctionnel offrant des solutions de rangement individuel. Grâce à son système de fermeture par code, il est spécialement conçu pour stocker ses effets personnels en toute sécurité. Avec ses 4 décors de portes et sa large colorimétrie, CAMILLE est ultra-personnalisable et s'adapte à tous les styles.

---

## SECURE & CUSTOMISABLE

**I**n keeping with the latest flex-office trend, CAMILLE is a functional piece of furniture offering a range of practical individual storage solutions. Secured with a number lock, it is purposely designed for the safe storage of personal belongings and valuables. With 4 distinct door designs and an extensive selection of colours to choose from, CAMILLE is ultra-customisable and fits in with any design style.

---

## VEILIG & PERSONALISEERBAAR

**A**ls functioneel lockermeubel sluit CAMILLE perfect aan bij de huidige tendens van 'flex offices'. Dankzij het vergrendelsysteem met code biedt het de ideale oplossing voor het veilig opbergen van persoonlijke bezittingen. Met de deuren in 4 uitvoeringen en het ruime kleurenaanbod is CAMILLE volkomen personaliseerbaar en integreerbaar in elke stijl.

---

**UN DESIGN EXCLUSIF**  
**AN EXCLUSIVE DESIGN**  
**EXCLUSIEF DESIGN**

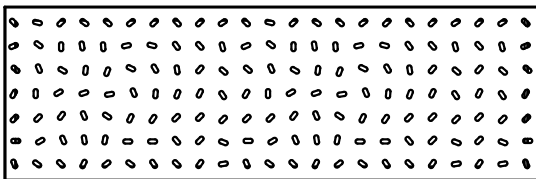

Bonbons  
 Sweets  
 Bonbons

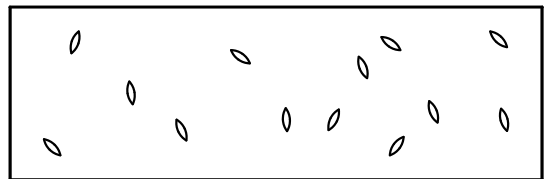

Feuilles  
 Leaves  
 Blaadjes

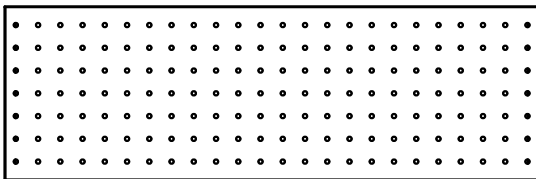

Pois  
 Dots  
 Punten

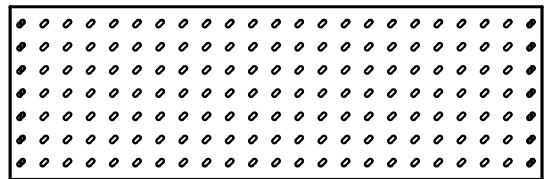

Biais  
 Slanted  
 Schuin

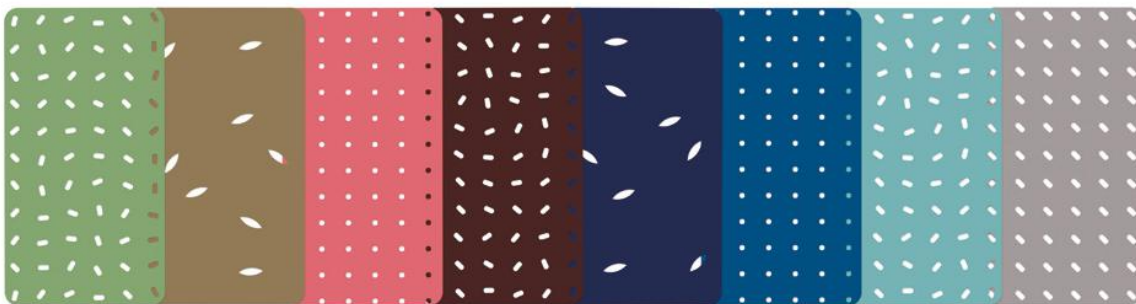

20 coloris dont 8 coloris exclusifs SIGNATURE BY EOL  
 20 colours including 8 SIGNATURE BY EOL exclusive colours  
 20 kleuren waarvan 8 exclusieve kleuren SIGNATURE BY EOL

---

Le meuble CAMILLE a été spécialement pensé et conçu par notre StudioDesign pour rendre chaque projet unique. Déclinables en 4 finitions métal exclusives et en 20 coloris au choix, c'est une multitude de styles qui s'offre à vous.

The CAMILLE storage unit was specially designed and conceived by our StudioDesign team, helping make every project unique. With 4 exclusive metal finishes and 20 different colours to choose from, the design style possibilities are endless.

Het CAMILLE lockermeubel werd door onze StudioDesign ontworpen en ontwikkeld om elk project uniek te maken. Met de 4 exclusieve uitvoeringen en het aanbod van 20 kleuren voor de metalen deuren biedt de collectie een antwoord op elke stijlvoorkeur.

---

**EN MODE PUBLIC...**  
**PUBLIC USAGE MODE...**  
**VOOR PUBLIEK GEBRUIK...**



Les casiers CAMILLE sont équipés d'un système d'ouverture à code mécanique. En mode public, un code différent est généré à chaque utilisation offrant un usage temporaire et non-fixe des différentes cases.

CAMILLE lockers are fitted with a mechanical number lock opening mechanism. In public usage mode a fresh code is generated with each new use, offering temporary and non-fixed access to individual lockers.

De CAMILLE lockerkasten zijn voorzien van een vergrendeling met mechanische code. Voor toepassing in publieke ruimten wordt bij elk gebruik een nieuwe code aangemaakt voor een tijdelijk en niet-persoonsgebonden gebruik van de lockers.



... OU PRIVÉ  
... OR PRIVATE  
... OF PRIVE-OMGEVINGEN



Le mode « privé » de la serrure CAMILLE est défini par l'utilisateur pour créer un espace de rangement individuel privatif. Les dimensions de cases ont été spécialement pensées pour accueillir des ordinateurs portables 15 pouces ou un casque de moto.

In "private" usage mode, CAMILLE's lock is under the control of a single user to create an entirely private storage compartment. Compartment dimensions have been designed specifically to accommodate items such as 15" laptop computers or motorbike helmets.

In geval van persoonlijk gebruik kan de gebruiker een unieke code kiezen voor de vergrendeling, waardoor CAMILLE individuele en persoonsgebonden opbergruimte biedt. De lockers zijn voldoende ruim voor bij voorbeeld 15 inch laptops of een motorhelm.

**DES FINITIONS SOIGNÉES**  
A HIGH QUALITY **FINISH**  
HOOGWAARDIG **AFGEWERKT**



Fabriqué dans nos usines françaises, le meuble CAMILLE est la garantie de finitions soignées et robustes. Au-delà de l'esthétisme, son décor perforé permet une aération du casier. CAMILLE s'adapte à tous vos besoins grâce à son mode de sécurité public/privé.

Made in our French production facilities, the CAMILLE locker unit stands out through its high-quality finishes and sturdy construction. As well as serving a decorative purpose, the perforations on the locker doors help to facilitate ventilation. CAMILLE is adaptable to all your needs thanks to its adjustable public/private security mode.

CAMILLE wordt vervaardigd in onze fabrieken in Frankrijk en staat garant voor een verzorgde en robuuste afwerking. De perforaties in de metalen deuren zijn niet alleen elegant, ze zorgen ook voor ventilatie van de lockers. Bovendien past CAMILLE zich aan elke gebruikstoepassing aan dankzij de publieke of private veiligheidsmodus.



Serrure à code avec mode privé ou public  
Number lock featuring public/private mode selection  
Codeslot met private of publieke modus



Perforation des portes pour l'aération du casier  
Perforations to locker door panels for better ventilation  
De perforaties zorgen voor verluchting van de lockers

**PERSONNALISER CAMILLE**  
**CUSTOMISE CAMILLE**  
**CAMILLE PERSONALISEREN**



Grâce à ses nombreuses combinaisons de couleurs et de finitions possibles, CAMILLE est ultra-personnalisable. De plus, vous pouvez choisir d'y ajouter une fente à courrier en fonction de vos besoins.

Thanks to its multiple possible colour combinations and finishes, CAMILLE is ultra-customisable. Depending on your usage requirements, you also have the option of specifying the inclusion of a mail slot.

Dankzij de talrijke kleurencombinaties en mogelijke uitvoeringen is CAMILLE volkomen personaliseerbaar. Indien gewenst kan ook een brievenleuf worden toegevoegd in de deuren.



Piètement en ABS de section carrée  
Square section ABS feet  
Vierkante ABS poten



Fente courrier  
Mail slot  
Briefengleuf

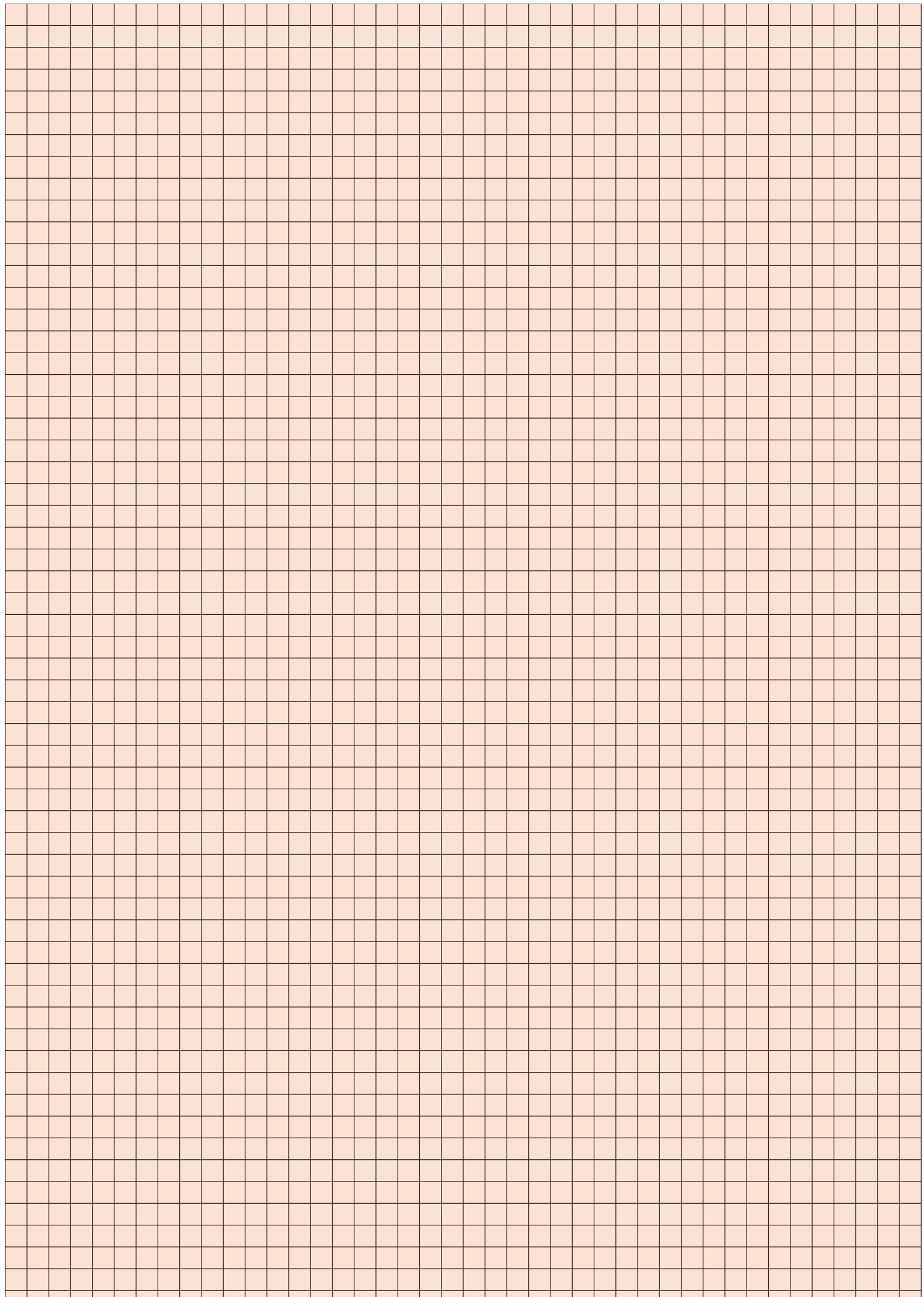

**SYNTHÈSE** & DIMENSIONS

—

**SUMMARY** & DIMENSIONS

**OVERZICHT** & AFMETINGEN

# GAMME RANGE COLLECTIE

Meubles 9 cases - 9 compartment storage units - Lockermeubel 9 vakken

---



Sans pieds  
Without feet  
Zonder poten



Avec pieds  
With feet  
Met poten

Meubles 12 cases - 12 compartment storage units - Lockermeubel 12 vakken

---

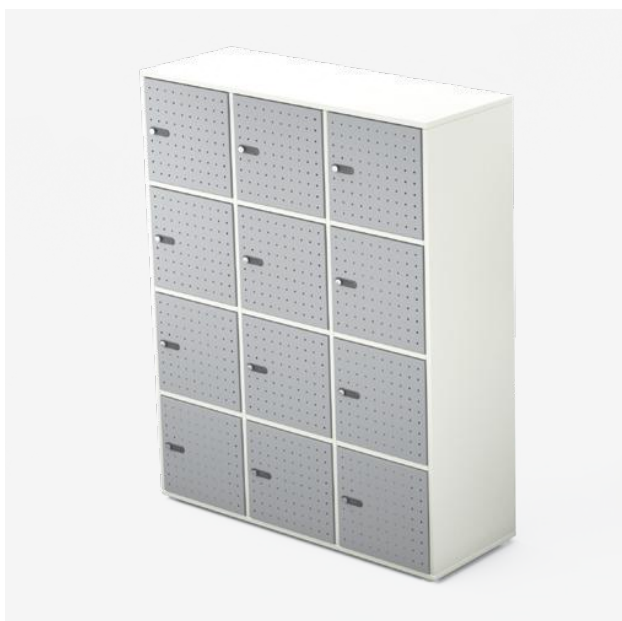

Sans pieds  
Without feet  
Zonder poten

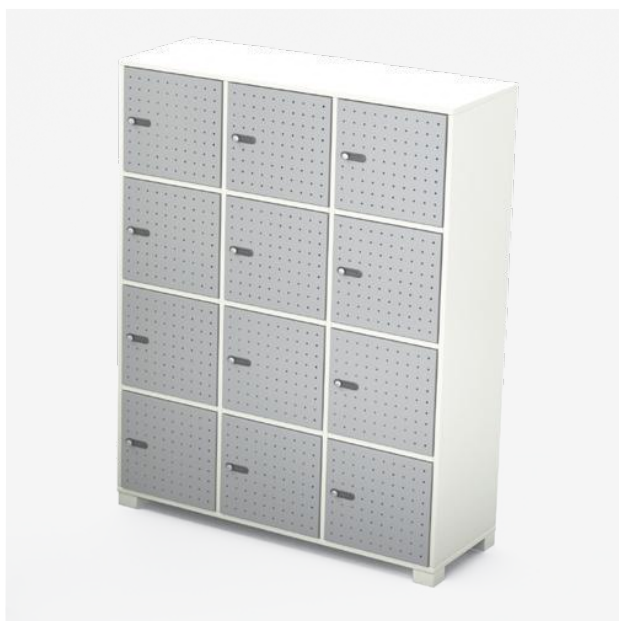

Avec pieds  
With feet  
Met poten



# SYNOPTIQUE OVERVIEW OVERZICHT

Meubles 9 cases - 9 compartment storage units - Lockermeubel 9 vakken

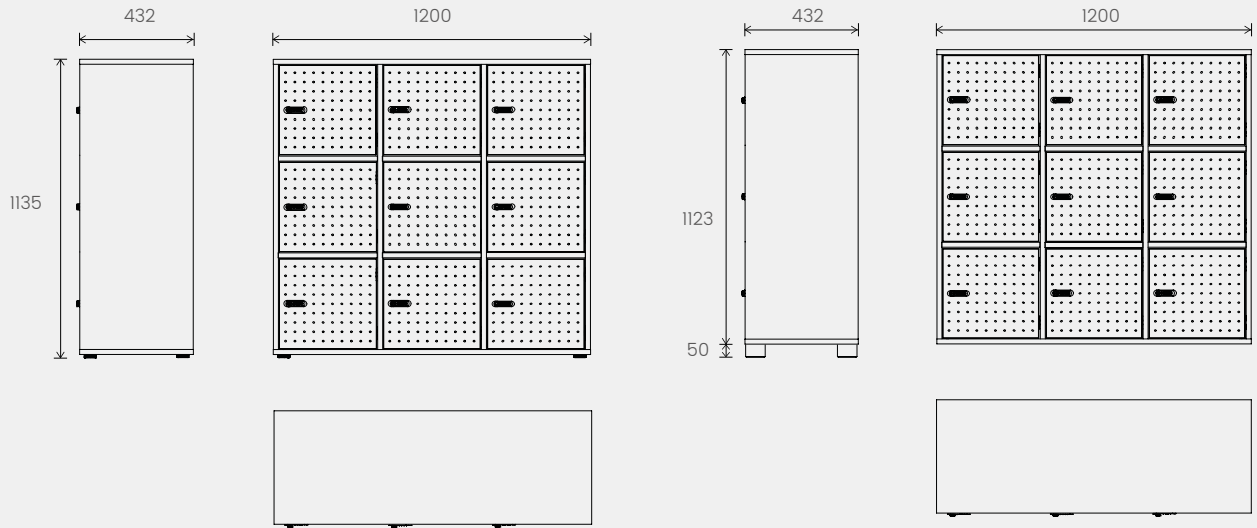

Meubles 12 cases - 12 compartment storage units - Lockermeubel 12 vakken

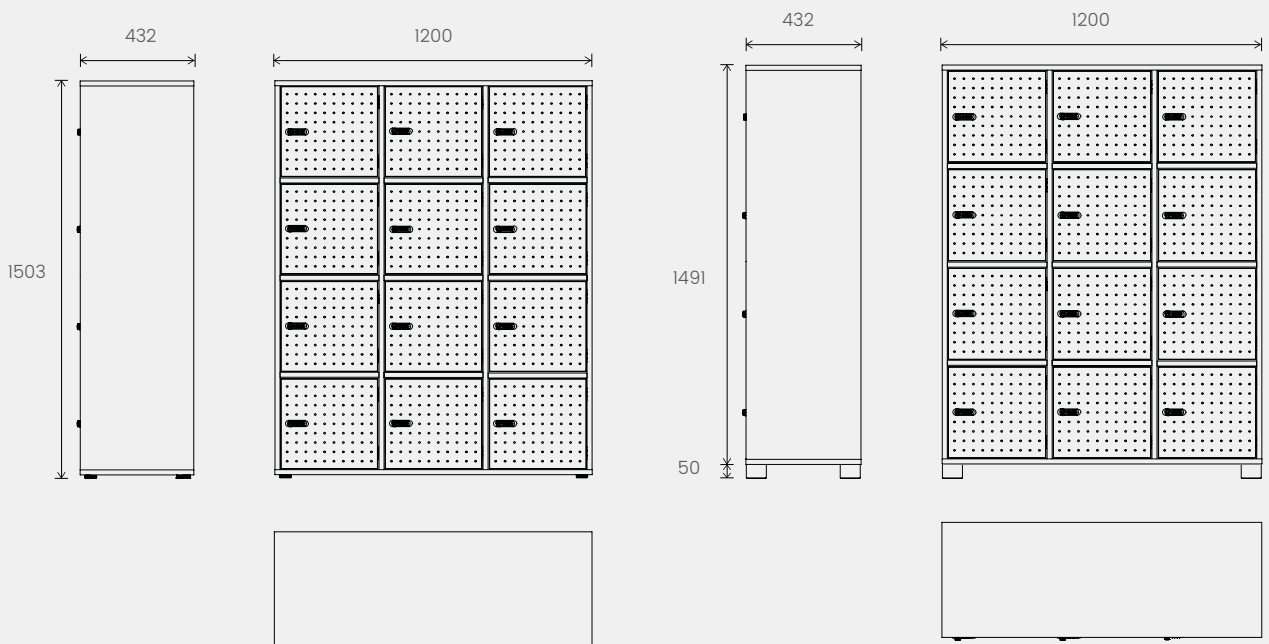

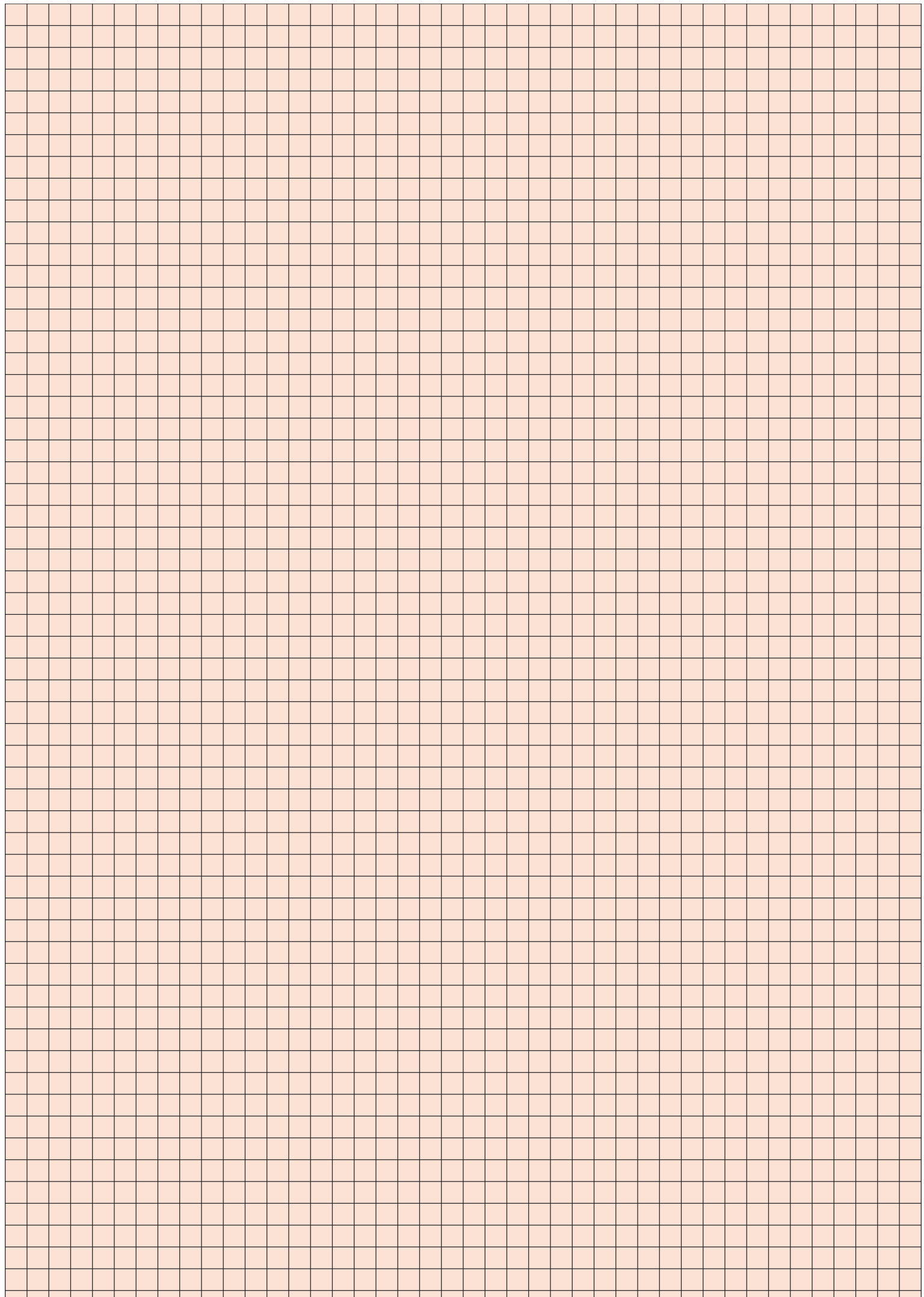

**MATIÈRES** & COULEURS

—

**MATERIALS** & COLOURS

**MATERIALEN** & KLEUREN

1. MÉLAMINE (corps d'armoire) – MELAMINE (storage unit shell) – MELAMINE (ambouv)

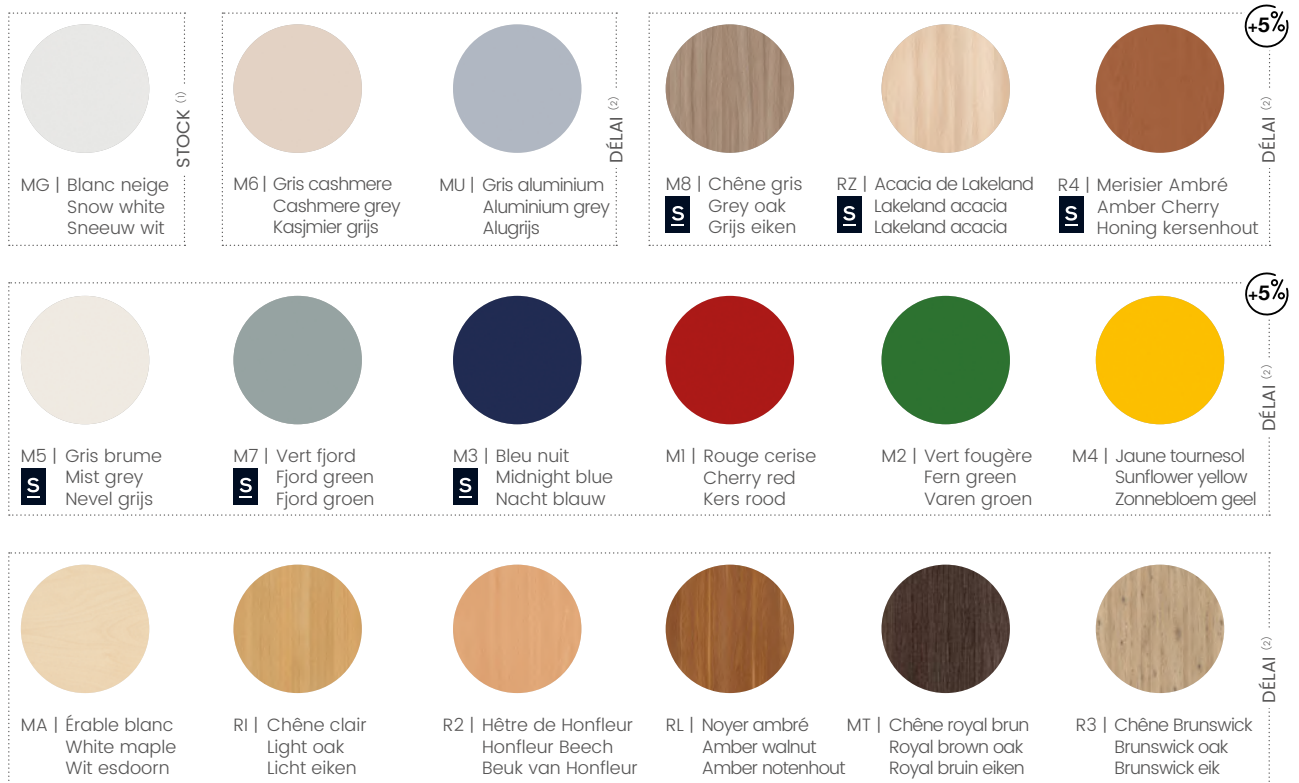

2. METAL (portes) – METAL (doors) – METAAL (deuren)



+5% majoration de 5% sur le PP HT indiqué  
5% mark-up on the RRP excl. tax  
meerprijs van 5% op de opgegeven verkoopprijs excl. BTW

(1) STOCK / STOCK / VOORRAAD  
(2) DÉLAI / ON REQUEST / MET LEVERTIJD

S Exclusivité / Exclusive to / Exclusiviteit  
SIGNATURE BY EOL

# CLAUDINE



Signature  
— BY EOL —



## ACOUSTIQUES & ESTHÉTIQUES

**G**âce à des propriétés insonorisantes, les armoires CLAUDINE permettent de séparer l'espace et d'offrir un confort acoustique propice à la concentration. Dotée de portes coulissantes et d'une grande capacité de rangement, CLAUDINE est une solution incontournable pour les nouveaux modes de travail. Particulièrement qualitative, la gamme CLAUDINE se distingue par son design épuré, ses finitions soignées et ses coloris élégants.

---

## SOUND ABSORBING & AESTHETICALLY PLEASING

**T**hanks to their sound-absorbing properties, CLAUDINE cupboards facilitate the partitioning of workspaces and ensure a level of acoustic comfort that favours concentration. Featuring sliding doors and a high storage capacity, CLAUDINE is the perfect solution for the latest working modes. A particularly high-quality range, CLAUDINE stands out thanks to its refined design, neat finishes and stylish choice of colours.

---

## GELUIDDEMPEND & ELEGANT

**M**et hun geluiddepende eigenschappen kunnen kasten CLAUDINE gebruikt worden om de ruimte op te delen en zo voor de medewerkers het nodige akoestisch comfort te creëren om zich te kunnen concentreren. De schuifdeuren en de grote opbergcapaciteit sluiten perfect aan bij onze nieuwe manieren van werken. Hoogwaardige materialen, uitgezuiverd design, verzorgde afwerking en elegante kleuren zijn de andere troeven van CLAUDINE.

---

**POUR STRUCTURER LES ESPACES OUVERTS...**  
**BRINGING STRUCTURE TO OPEN SPACES...**  
**STRUCTUUR BRENGEN IN OPEN RUIMTEN...**



Les espaces de travail ouverts ont le vent en poupe. Cependant, ils sont souvent synonymes de niveaux sonores élevés et peu propices à la concentration. CLAUDINE a été spécialement conçue pour répondre à cette problématique. Elle permet une absorption efficace des nuisances sonores et un cloisonnement des espaces partagés.

Open space workplaces are growing in popularity. However, they are often thought of as noisy environments that are unlikely to favour concentration. CLAUDINE is specially designed to offer a solution to this problem. It enables an efficient absorption of disruptive ambient sound, as well as the partitioning of shared spaces.

Open space kantoorruimten zijn de laatste jaren de norm geworden. Het enige nadeel dat aangehaald wordt, is het geluidsniveau dat de concentratie kan verstoren. CLAUDINE werd speciaal ontworpen om daarop een antwoord te bieden: kasten met geluiddempende eigenschappen om de ruimte op te delen.



**...ET OPTIMISER LE RANGEMENT**  
**...AND OPTIMISING STORAGE**  
**... EN TEGELIJK PRAKTISCHE OPBERGRUIMTE VOORZIEN**



Très pratiques grâce à leurs portes coulissantes, les armoires CLAUDINE peuvent se placer à proximité du poste de travail tout en offrant une grande capacité de rangement. De plus, elles offrent un rangement fonctionnel et organisé grâce aux rails encastrés pour dossiers suspendus.

Extremely practical thanks to their sliding doors, CLAUDINE cupboards can be positioned in close proximity to the workstation whilst offering a high storage volume. Additionally, they offer a functional and structured storage solution thanks to integrated suspension file rails.

CLAUDINE is erg praktisch in gebruik met plaatsbesparende schuifdeuren en veel opbergruimte binnen handbereik. Bovendien kunnen ze functioneel ingericht worden dankzij de geïntegreerde rails voor hangmappen.

**UNE ARMOIRE ESTHÉTIQUE**  
**A VISUALLY APPEALING CUPBOARD**  
**EEN KAST MET STIJL**



CLAUDINE se distingue par son design épuré et moderne, fruit de ses finitions microperforées en métal et de ses poignées discrètes. Avec son style architectural et ses matériaux qualitatifs, CLAUDINE est résolument haut de gamme. Dessinée pour être compacte et esthétique, elle s'intègre parfaitement dans tous les environnements de travail.

CLAUDINE stands out through its distinctly refined and modern design achieved, in part, thanks to micro-perforated metal finishes and unobtrusive handles. With its architectural styling and use of premium quality materials, CLAUDINE is a decisively high-end offering. Conceived to be compact and aesthetically appealing, it fits in perfectly within all work environments.

CLAUDINE onderscheidt zich met zijn uitgezuiverd en eigentijds design, de microperforaties in het metaal en de discrete handgrepen. Met zijn architecturale stijl en hoogwaardige materialen kan CLAUDINE resoluut een topcollectie genoemd worden. Compact, stijlvol en perfect integreerbaar in elke werkomgeving.



Décor des portes  
Doors finish  
Decor van de deuren



Rail encastré  
Built-in rail  
Geïntegreerde rail



Poignée de préhension encastrée  
Recessed grip handle  
Ingewerkte handgreep

**PERSONNALISER** CLAUDINE  
**CUSTOMISE** CLAUDINE  
CLAUDINE **PERSONALISEREN**



Pour une fermeture douce et silencieuse, vous pouvez compléter CLAUDINE avec un système d'amortissement soft-closing. Des tablettes peuvent être ajoutées pour structurer votre espace de rangement selon vos besoins. De plus, un top en mélamine ou en verre permet de parfaire le style de votre armoire.

CLAUDINE can be optionally fitted with a soft-close mechanism for a quiet and discreet closing action. Shelves are also available to further structure your storage space to suit your needs. A melamine or glass decorative top can also be added to round off your cupboard's look.

Voor een zachte en stille sluiting van de schuifdeuren kan CLAUDINE worden aangevuld met een soft-closing dempsysteem. Er kunnen ook legborden worden toegevoegd om de kasten volledig naar wens in te richten. Het melamine of glazen topblad maakt de afwerking van uw kast compleet.



Top mélamine  
Melamine top  
Melamine topblad



Fermeture soft-closing  
Soft-close mechanism  
Soft-closing system



Tablettes additionnelles  
Additional shelves  
Extra legborden



Top verre  
Glass top  
Glazen topblad

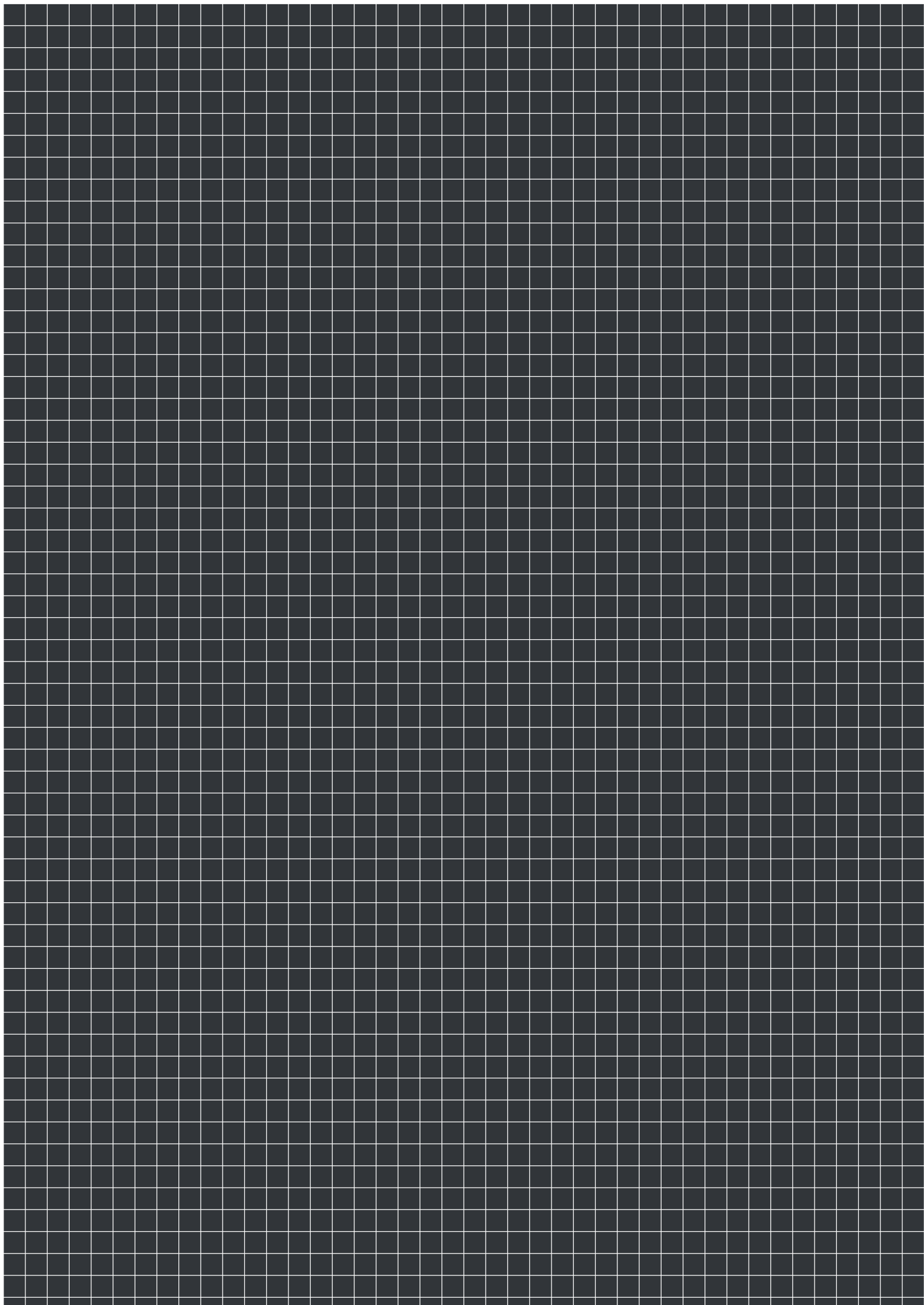

**SYNTHÈSE** & DIMENSIONS

—

**SUMMARY** & DIMENSIONS

**OVERZICHT** & AFMETINGEN

# GAMME RANGE COLLECTIE

Armoires 2 portes coulissantes - Cupboards with 2 sliding - Kast met 2 schuifdeuren

---



Largeur 1 200 mm  
Width 1 200 mm  
Breedte 1 200 mm



Largeur 1 600 mm  
Width 1 600 mm  
Breedte 1 600 mm



Largeur 2 000 mm  
Width 2 000 mm  
Breedte 2 000 mm



# SYNOPTIQUE

## OVERVIEW

## OVERZICHT

Armoires 2 portes coulissantes – Cupboards with 2 sliding – Kast met 2 schuifdeuren

Largeur 1 200 mm – Width 1 200 mm – Breedte 1 200 mm

Largeur 1 600 mm – Width 1 600 mm – Breedte 1 600 mm

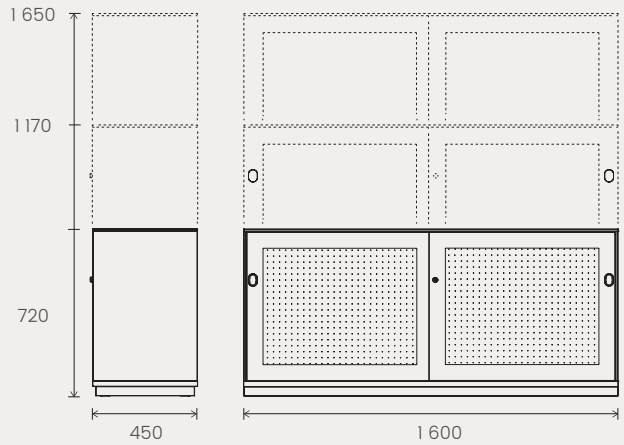
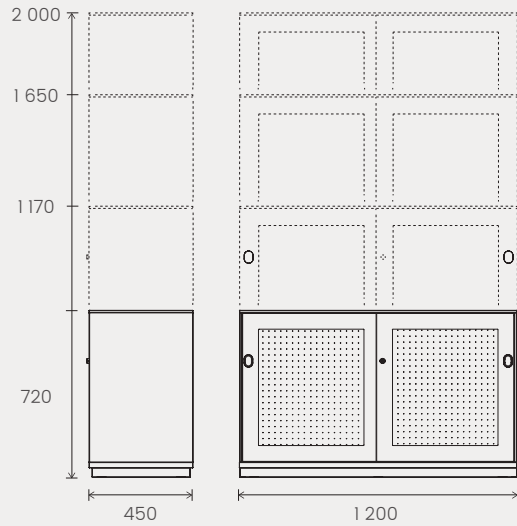

Largeur 2 000 mm – Width 2 000 mm – Breedte 2 000 mm

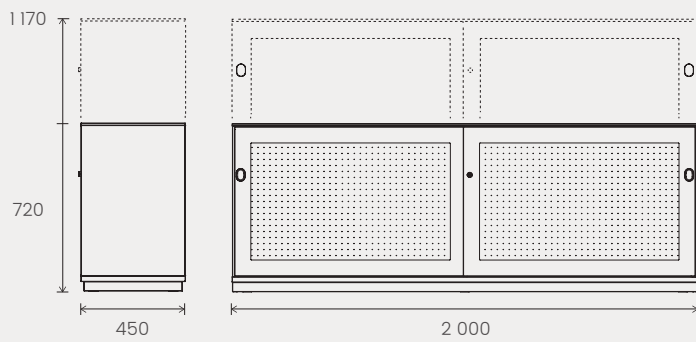

**MATIÈRES** & COULEURS

—

**MATERIALS** & COLOURS

**MATERIALEN** & KLEUREN

1. MÉTAL<sup>(2)</sup> (Coloris pour le corps et coloris pour les portes) - METAL<sup>(2)</sup> (Colors for the shell and colors for the doors) - METAAL<sup>(2)</sup> (Kleuren voor de ombouw en kleuren voor de deuren)



2. ABS<sup>(2)</sup> (poignées) - ABS<sup>(2)</sup> (handles) - ABS<sup>(2)</sup> (handgrepen)



3. MÉTAL (socle) - METAL (base) - METAAL (sokkel)



4. VERRE (top ép. 10 mm) - GLASS (top 10 mm thick) - GLAS (topblad dikte 10 mm)



5. MÉLAMINE (top ép. 19 mm) - MELAMINE (top 19 mm thick) - MELAMINE (topblad dikte 19 mm)



<sup>(1)</sup> DÉLAI / ON REQUEST / MET LEVERTIJD

<sup>(2)</sup> Autres coloris, nous consulter - Other colours: contact us for details - Andere kleuren: vraag inlichtingen

+5% majoration de 5% sur le PP HT indiqué  
5% mark-up on the RRP excl. tax  
meerprijs van 5% op de opgegeven verkopprijs excl. BTW

# GUSTAVE

Conçu pour optimiser la surface de travail du bureau, GUSTAVE est le rangement de proximité idéal. Les caissons Tower offrent une utilisation quotidienne à la fois pratique et agréable, améliorant l'accessibilité et l'utilité de vos rangements.



- Bureaux collaboratifs, page 57
- Sièges ergonomiques, page 195



## Pratique & multifonctionnel

Gamme complète  
d'accessoires

Grande poignée en  
aluminium pour une  
préhension optimale

Réversible, montage  
droite ou gauche



Glissière à fermeture  
douce avec amorti fin  
de course silencieux

Personnaliser le coloris  
de la façade

Kit optionnel  
d'électrification

## FINITIONS &amp; SYNOPTIQUE

4 décors  
mélamine  
de corps  
(+ fin.)

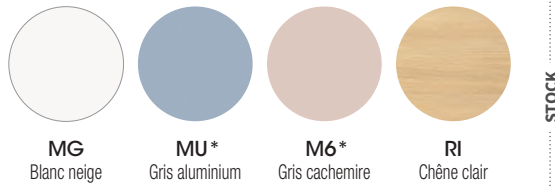

11 décors  
mélamine  
de portes  
et tops  
(+ décor)

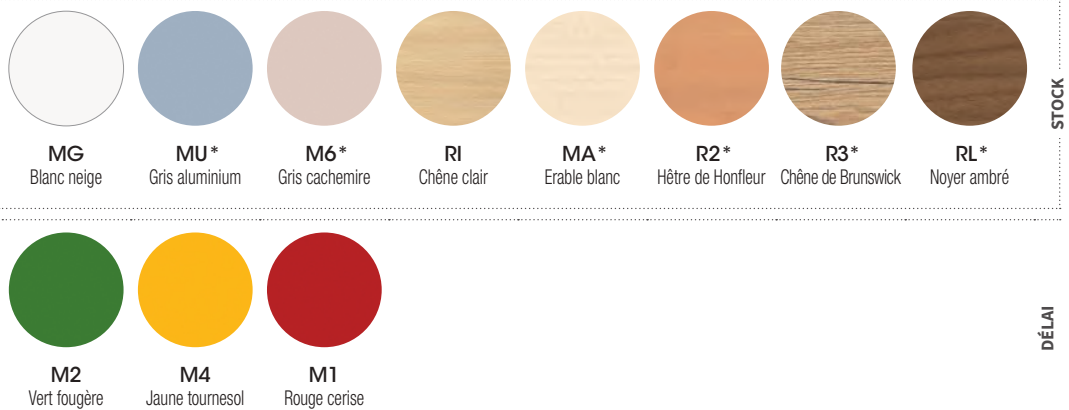

6 finitions  
métal pour  
options  
(+ col.)

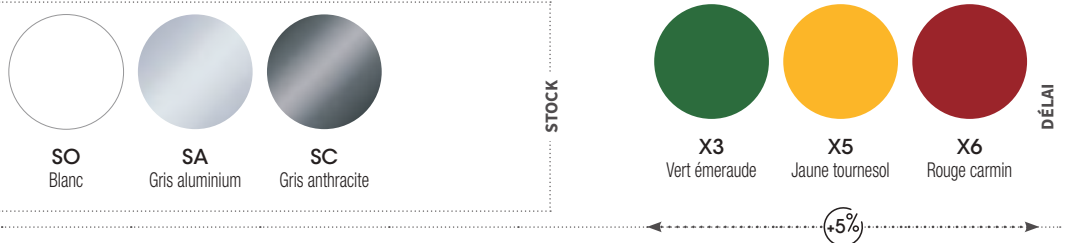

\* Sur délai pour les caissons P. 70 cm

DÉLAI : 8 semaines

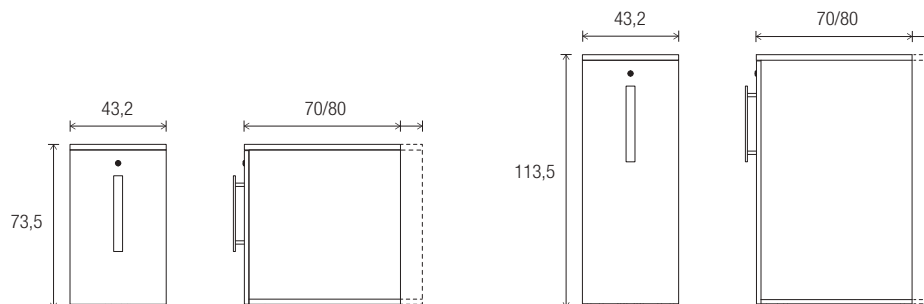

## COMMENT COMMANDER ?

Pour les caissons EXTENSION DE BUREAU

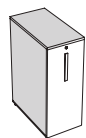

+



+

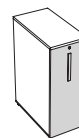

1. Choisissez le décor DU CORPS DE CAISSON

2. Choisissez le décor DU TOP DE FINITION

3. Choisissez le décor DE FAÇADE

# TARIF

En stock

Sur délai

## CAISSON TOWER

### Hauteur bureau 73,5 cm - corps unis et coloris de façade au choix

P. 80 cm

2 302 015 + fin + décor

P. 70 cm

2 302 020 + fin + décor

### Extension de bureau H. 73,5 cm - coloris de corps, façade et top au choix

P. 80 cm

2 302 016 + fin + décor + décor

P. 70 cm

2 302 021 + fin + décor + décor

### Hauteur comptoir 113,5 cm - corps unis et coloris de façade au choix

P. 80 cm

2 302 017 + fin + décor

P. 70 cm

2 302 022 + fin + décor

## OPTIONS POUR CAISSON TOWER

### Électrification

Se fixe sur les deux préperçages présents sur la paroi du fond. Un rail en partie haute permet de maintenir les câbles à l'aide de crochets. Une ouverture en partie basse permet le passage du câble à l'extérieur du caisson.

1 prise courant + 2 USB de charge - FR

6 097 056

### Rails et accessoires

En métal epoxy. Se fixe grâce aux 2 boutons en plastique vissés sur les inserts de la paroi verticale des caissons.



Rail L. 62 cm - pour caisson P. 80 cm

2 302 009 + col.

Rail L. 52 cm - pour caisson P. 70 cm

2 302 013 + col.



Bac à courrier départ - L. 33,5 x H. 6 x P. 25,5 cm

7 626 014 + col.



Bac à courrier suivant - L. 33,5 x H. 6 x P. 25,5 cm

7 626 015 + col.



Jardinière 3 bacs

7 626 016 + col.



Tableau magnétique - Fourni sans boutons

6 386 120 + col.



Étagère

7 626 017 + col.

Plumier

6 386 121 + col.

### Fileurs

Comblent et homogénéisent l'espace laissé entre 2 caissons dos à dos.

Fileur pour H. 73,5 cm

2 302 010 + col.

Fileur pour H. 113,5 cm

2 302 011 + col.

### Accessoires DS\* pour tablette mélamine

À fixer par vis à bois sur la longueur de la tablette. Permet la pose de dossiers suspendus. Attention : vérifier la dimension en fonction du format des dossiers suspendus.

Support DS - 65 cm - pour caisson P. 80 cm

2 302 012 + SO

Support DS - 55 cm - pour caisson P. 70 cm

2 302 014 + SO

\* Dossiers suspendus.

# NAVERT

Robuste par sa conception monobloc et pratique par ses accessoires, NAVERT est la solution idéale pour un usage quotidien. La structure des armoires a été conçue pour assurer une rigidité optimale tout en vous offrant un grand confort d'usage grâce aux rideaux à ouverture totale et de nombreuses options de rangement permettant un accès facile aux dossiers.





Armoires à rideaux H. 100 cm et H. 198 cm.  
Décors SOSO, corps blanc, rideaux blancs.



- Bureaux collaboratifs, page 57
- Sièges ergonomiques, page 195
- Accessoires de bureau, page 253



## Pratique & robuste

Fixation des  
tablettes sur taquets  
métalliques

Tablettes et haut  
d'armoires équipés  
d'une **tablette** pour  
dossiers suspendus



Armoires monobloc  
à rideaux PVC non  
feu M1



Vérins de réglage  
à l'intérieur

Un choix complet  
d'options pour  
aménager l'armoire

Fond plat pour  
les dossiers du  
bas, accessibles  
facilement

# FINITIONS



**Corps unis**

Cat. 1      Cat. 2

**SOSO** Blanc  
**SDSD** Gris clair  
**SCSC** Anthracite  
**SGSG** Noir  
**SBSB** Gris aluminium

STOCK

**16**  
décor  
de rideaux  
et corps  
d'armoires  
(+ fin.)

**Corps blanc - Cat. 2**      **Corps aluminium - Cat. 2**

**MASO** Érable/blanc  
**RISO** Chêne clair/blanc  
**R2SO** Hêtre/blanc  
**SOSB** Blanc/alu.  
**MASB** Érable/alu.  
**RISB** Chêne clair/alu.  
**R2SB** Hêtre/alu.

STOCK

**Corps anthracite - Cat. 2**

**R2SC** Hêtre/anthracite  
**SOSC** Blanc/anthracite  
**MASC** Érable/anthracite  
**RISC** Chêne clair/anthr.

STOCK      DÉLAI

**11**  
décor  
mélamine  
du top  
d'armoires  
(+ décor)

**MG** Blanc neige  
**M6** Gris cachemire  
**MA** Érable blanc  
**R2** Hêtre de Honfleur  
**RI** Chêne clair  
**R3** Chêne Brunswick  
**RL** Noyer ambré  
**M2** Vert fougère  
**M4** Jaune tournesol  
**M1** Rouge cerise  
**MT** Chêne royal brun

STOCK      DÉLAI

(+5%)

**2**  
finitions  
métal pour  
tablettes  
(+ col.)

**SO\*** Blanc  
**SG\*** Noir

STOCK







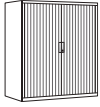
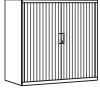

DÉLAI : 4 semaines

\* Tablette blanche avec corps unis blanc et noir pour les autres finitions de corps.

## TARIF









En stock

Sur délai

ARMOIRES À RIDEAUX - P. 43 CM		Réf.	Cat.1	Cat.2	
	<b>H. 198 cm</b> - 4 tablettes - 5 HC*				
	L. 120 cm	4 425 002 + fin.			
	L. 100 cm	4 425 019 + fin.			
	L. 80 cm	4 425 013 + fin.			
	<b>H. 160,8 cm</b> - 3 tablettes - 4 HC*				
	L. 120 cm	4 425 022 + fin.			
		<b>H. 136 cm</b> - 3 tablettes - 3 HC*			
		L. 120 cm	4 425 025 + fin.		
	L. 100 cm	4 425 026 + fin.			
	<b>H. 120 cm</b> - 2 tablettes - 3 HC*				
	L. 120 cm	4 425 028 + fin.			
	<b>H. 100 cm</b> - 2 tablettes - 2 HC*				
	L. 120 cm	4 425 001 + fin.			
	L. 100 cm	4 425 020 + fin.			
	L. 80 cm	4 425 015 + fin.			
	<b>H. 72,6 cm</b> - 1 tablette - 2 HC*				
	L. 120 cm	4 425 040 + fin.			
	L. 100 cm	4 425 043 + fin.			
	L. 80 cm	4 425 045 + fin.			
	<b>H. 71 cm</b> - 1 tablette - 1 HC*				
	L. 120 cm	4 425 041 + fin.			
	L. 100 cm	4 425 044 + fin.			
	L. 80 cm	4 425 046 + fin.			
	<b>H. 44 cm</b> - 1 HC*				
	L. 120 cm	4 425 042 + fin.			
	L. 100 cm	4 425 032 + fin.			

\* Hauteur classeurs.

## ACCESSOIRES NAVERT

			Réf.	
	<b>Top d'armoire en mélamine</b>	L. 120 cm	4 470 052 + décor	
		L. 100 cm	4 470 051 + décor	
		L. 80 cm	4 470 050 + décor	
	<b>Tablettes supplémentaires</b> Permettent l'accrochage de dossiers suspendus	L. 120 cm	4 470 071 + col.	
		L. 100 cm	4 470 179 + col.	
		L. 80 cm	4 470 220 + col.	
		L. 60 cm	4 470 221 + col.	
	<b>Séparateur vertical</b> Vendu par jeu de 5 - H.18 cm	L. 120 cm	4 470 222 + SG	
	<b>Tablettes télescopiques</b> Tablette extractible montée sur 2 coulisses à billes à sortie totale	L. 120 cm	4 470 228 + SG	
		L. 100 cm	4 470 229 + SG	
		L. 80 cm	4 470 230 + SG	
	<b>Tablettes de consultation</b> Tablette fixe avec tablette de consultation intégrée	L. 120 cm	4 470 223 + SG	
		L. 100 cm	4 470 226 + SG	
		L. 80 cm	4 470 227 + SG	
	<b>Châssis télescopiques</b> Système anti-basculement.	L. 120 cm	4 470 061 + SG	
		L. 100 cm	4 470 059 + SG	
		L. 80 cm	4 470 224 + SG	
	<b>Tablette penderie</b> Pour armoire L. 60 cm	L. 120 cm	4 470 225 + SG	
	<b>Dossiers suspendus (lot de 50)</b> Étiquettes fournies	Fond V - AM	4 464 005 + ZH	
		Fond V - T + C*	4 464 002 + ZH	
		Fond 15 mm - AM	4 464 004 + ZH	
		Fond 15 mm - T + C*	4 464 001 + ZH	
		Fond 30 mm - AM	4 464 006 + ZH	
		Fond 30 mm - T + C*	4 464 003 + ZH	

\* T + C = tiroir + chassis - AM = armoire.

## FINITIONS

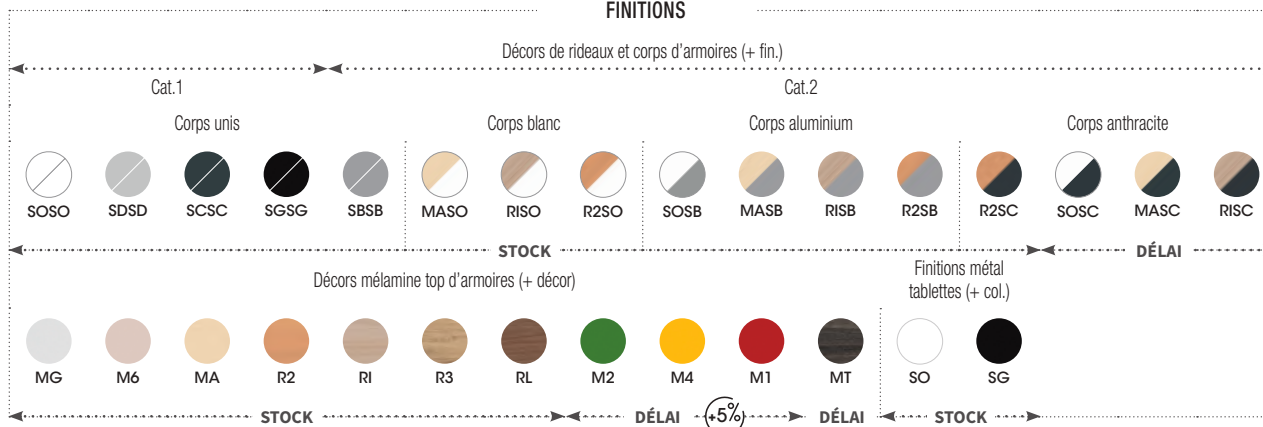

DÉLAI : 4 semaines

# ARIV

+ Organisée & classique

Tablettes assorties au corps de l'armoire



Structure monobloc



## ATOUTS



Réglage des vérins intérieur



Lame terminale aimantée pour une fermeture agréable



Tablettes et haut d'armoire équipés pour recevoir des dossiers suspendus



# FINITIONS



14

décors de rideaux et corps d'armoires (+ décor)

Corps unis

Cat. 1      Cat. 2

**SOSO**  
Blanc

**SDSD**  
Gris clair

**SGSG**  
Noir

**SCSC**  
Anthracite

**SBSB**  
Gris aluminium

STOCK

Corps blanc - Cat. 2

**RISO**  
Chêne clair/blanc

**RLSO**  
Noyer/blanc

STOCK

DÉLAI

Corps aluminium - Cat. 2

**SOSB**  
Blanc/alu.

**MASB**  
Érable/alu.

**RISB**  
Chêne clair/alu.

**RLSB**  
Noyer/alu.

STOCK

DÉLAI

Corps anthracite - Cat. 2

**SOSC**  
Blanc/anthracite

**MASC**  
Érable/anthracite

**RISC**  
Chêne clair/anthr.

DÉLAI

5

finitions métal pour tablettes (+ fin.)

**SO**  
Blanc

**SD**  
Gris clair

**SB**  
Gris aluminium

**SG**  
Noir

**SC**  
Anthracite

STOCK

DÉLAI : 8 semaines

## TARIF

En stock







Sur délai

ARMOIRES À RIDEAUX - P.43 CM	Réf. + décor	Cat.1	Cat.2	Cat.1	Cat.2
		L. 120 cm		L. 100 cm	
H. 198 cm - 4 tablettes + rail - 5 HC*	4 436 020			4 436 019	
H. 118 cm - 2 tablettes + rail - 3 HC*	4 436 055			4 436 054	
H. 105 cm - 2 tablettes + rail - 2 HC*	4 436 008			4 436 007	
H. 72,1 cm - 1 tablette + rail - 2 HC*	4 436 152			4 436 151	
H. 71 cm - 1 tablette + rail - 1 HC*	4 436 158			4 436 157	
		L. 80 cm		L. 60 cm	
H. 198 cm - 4 tablettes + rail - 5 HC*	4 436 018			4 436 017	
H. 105 cm - 2 tablettes + rail - 2 HC*	4 436 006				
H. 72,1 cm - 1 tablette + rail - 2 HC*	4 436 150				
H. 71 cm - 1 tablette + rail - 1 HC*	4 436 156				

\* Hauteur classeurs.















## ACCESSOIRES ARIV

Finition gris anthracite SC

		Réf.	
	<b>Tablettes supplémentaires</b> Permettent l'accrochage de dossiers suspendus	L. 120 cm	4 470 040
		L. 100 cm	4 470 039
		L. 80 cm	4 470 038
		L. 60 cm	4 470 037
	<b>Châssis télescopiques</b> Système anti-basculement. Incompatible avec l'armoire L. 80 x H. 72,1 cm	L. 120 cm	4 470 045 + SC
		L. 100 cm	4 470 044 + SC
		L. 80 cm	4 470 043 + SC
	<b>Séparateur vertical</b> Vendu par jeu de 2 - H. 19 cm	L. 120 cm	4 470 042 + SC
	<b>Trieur 16 cases format A4</b> À poser sur une tablette L. 120 cm L. 104 x P. 33 x H. 32 cm	L. 120 cm	4 470 041 + SC
	<b>Tablette de consultation</b>	L. 120 cm	4 470 048 + SC
	<b>Traverses et arceaux</b> Permettent de classer 3 rangées de dossiers suspendus de face	L. 120 cm	4 470 046 + SC
	<b>Tablette penderie</b> Pour armoire L. 60 cm uniquement	L. 120 cm	4 470 032 + SC

\* Top d'armoire disponible

## FINITIONS

Décor de rideaux et corps d'armoires (+ fin.)															
Cat.1					Cat.2										
Corps unis					Corps blanc				Corps aluminium				Corps anthracite		
															
STOCK					DÉLAI				STOCK				DÉLAI		



# ARMOIRES DÉMONTABLES



Partie haute avec rails pour dossiers suspendus

Tablettes équipées pour recevoir des dossiers suspendus

Lame terminale aimantée avec serrure 2 points

Armoire L. 160 cm avec séparation médiane et tablettes L. 80 cm

Serrure fournie avec 2 clés pliantes

Rideaux PVC non feu M1

	Réf.	
<b>Armoires H.198 x P. 45 cm &gt; 4 tablettes + rail</b>		
L. 100 cm	4 399 423 + décor	
L. 120 cm	4 399 424 + décor	
L. 160 cm	4 399 425 + décor	
<b>Armoires H.100 x P. 45 cm &gt; 2 tablettes + rail</b>		
L. 100 cm	4 399 420 + décor	
L. 120 cm	4 399 421 + décor	
L. 160 cm	4 399 422 + décor	
<b>Tablettes supplémentaires (vendues par 2)</b> Finition gris clair SD, gris aluminium SB ou gris anthracite SC (+ fin.)		
L. 100 cm	4 399 426 + fin.	
L. 120 cm	4 399 427 + fin.	
L. 160 cm (2 x 80 cm)	4 399 428 + fin.	
<b>Châssis télescopique</b>		
L. 120 cm	4 399 418 + SC	

**FINITIONS**



**SDSD**  
Gris clair



**SBSB**  
Gris aluminium



**SCSC**  
Gris anthracite

**STOCK**

# ARMOIRES PORTES BATTANTES



Partie haute de l'armoire et tablettes équipées pour recevoir des dossiers suspendus

Poignée encastrée  
Serrure 2 points munie de 2 clés

Armoires monobloc

	Réf.	
<b>Armoires H.195 x P. 42 cm &gt; 4 tablettes + rails</b>		
L. 92 cm	4 330 012 + fin.	
L. 120 cm	4 330 011 + fin.	
<b>Armoires H.100 x P. 42 cm &gt; 2 tablettes + rails</b>		
L. 92 cm	4 330 010 + fin.	
<b>Options &gt; Lots de 2 tablettes</b>		
L. 92 cm	4 330 014 + fin.	
L. 120 cm	4 330 013 + fin.	

**FINITIONS**



**SD**  
Gris clair



**SC**  
Gris anthracite

**STOCK**

# CLASSEURS DOSSIERS SUSPENDUS



Serrure centralisée  
(clé passe sur demande)

En option : fond cranté pouvant  
recevoir des intercalaires

Ouverture sélective  
des tiroirs et système de sécurité  
anti-basculement

Poignées ergonomiques  
et porte-étiquettes intégrés

Glissières télescopiques  
à billes avec aspiration  
en fin de course

	Réf.	
<b>Classeurs format A4 - P. 62,2 x L. 41,3 cm</b>		
2 tiroirs - H. 71,1 cm	4 333 001 + fin.	
3 tiroirs - H. 101,6 cm	4 333 002 + fin.	
4 tiroirs - H. 132,4 cm	4 333 003 + fin.	
<b>Option</b>		
Fond cranté - pour 1 tiroir + 2 intercalaires	4 333 019 + SC	

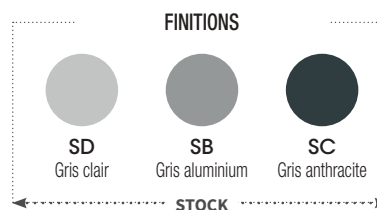

Conformes aux normes : - NF D.62041 (France) - GS. 93123051 (Allemagne) - BS. 54459 (Angleterre).

# CRÉDENCES



Serrure centralisée.  
Poignées ergonomiques  
et porte-étiquettes intégrés

Classement de 1 à 3 rangées  
de dossiers suspendus A4  
par tiroir

Ouverture sélective  
des tiroirs et système de  
sécurité anti-basculement

Glissières télescopiques  
à billes, extraction 100 %

	Réf.	
<b>3 tiroirs H. 100 cm</b>		
L. 80 cm	4 602 001 + fin.	
L. 120 cm	4 602 002 + fin.	
<b>4 tiroirs H. 132 cm</b>		
L. 80 cm	4 602 005 + fin.	

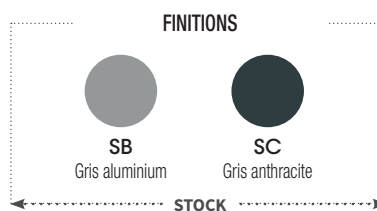

Conformes aux normes : - NF D.62041 (France) - GS. 93123051 (Allemagne) - BS. 4875 (Angleterre).

# CLASSEURS À TIROIRS

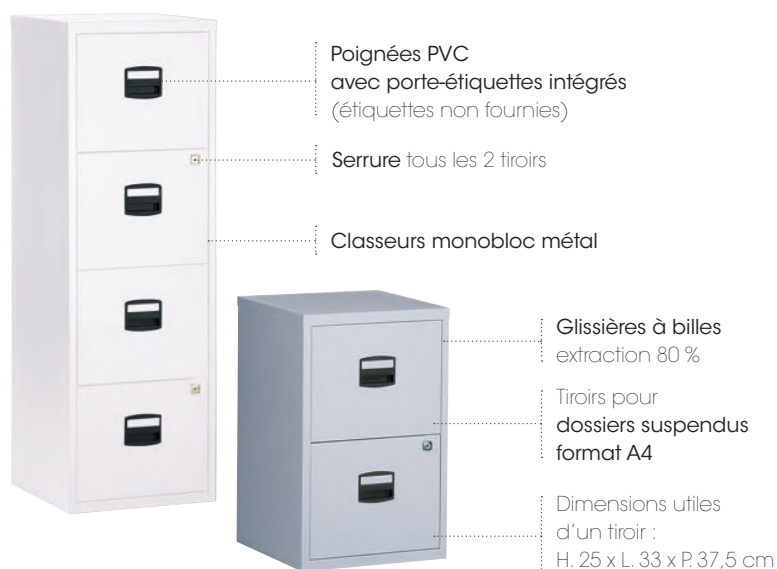

	Réf.	
P. 40 x L. 41,3 cm		
2 tiroirs	4 614 002 + fin.	[Color swatch]
4 tiroirs	4 614 001 + fin.	
<b>FINITIONS</b>		
SO Blanc	SB Gris aluminium	SG Noir
STOCK		

# MEUBLES À CLAPETS



	Réf. + fin.	
P. 34,5 x L. 41 cm		
5 cases	4 334 003	[Color swatch]
10 cases	4 334 004	
<b>FINITIONS</b>		
SD Gris clair	SB Gris aluminium	SC Gris anthracite
STOCK		

# RAYONNAGES TUBULAIRES

+ Simple & robuste



Montage rapide  
par simple  
emboîtement

Tablette composée  
de 3 traverses en  
acier galvanisé  
200 kg max. par traverse

Dessus Isorel  
optionnel





Montants profilés en T  
peints ou galvanisés  
Acier ép. 8/10 mm



# TARIF

En stock

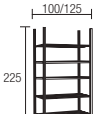
Sur délai

RAYONNAGES TUBULAIRES	Réf. + fin.	DÉPART		SUIVANT		
		Montants peints	Montants galvanisés	Montants peints	Montants galvanisés	
 <p><b>H. 175 cm - L. 100 cm - 4 traverses</b></p> <p>P. 35 cm 4 226 068</p> <p>P. 50 cm 4 226 069</p> <p>P. 70 cm 4 226 070</p> <p><b>H. 175 cm - L. 125 cm - 4 traverses</b></p> <p>P. 35 cm 4 226 074</p> <p>P. 50 cm 4 226 075</p> <p>P. 70 cm 4 226 076</p>						
 <p><b>H. 200 cm - L. 100 cm - 5 traverses</b></p> <p>P. 35 cm 4 226 050</p> <p>P. 50 cm 4 226 051</p> <p>P. 70 cm 4 226 052</p> <p><b>H. 200 cm - L. 125 cm - 5 traverses</b></p> <p>P. 35 cm 4 226 053</p> <p>P. 50 cm 4 226 054</p> <p>P. 70 cm 4 226 055</p>						
 <p><b>H. 225 cm - L. 100 cm - 6 traverses</b></p> <p>P. 35 cm 4 226 080</p> <p>P. 50 cm 4 226 081</p> <p>P. 70 cm 4 226 082</p> <p><b>H. 225 cm - L. 125 cm - 6 traverses</b></p> <p>P. 35 cm 4 226 086</p> <p>P. 50 cm 4 226 087</p> <p>P. 70 cm 4 226 088</p>						
 <p><b>H. 250 cm - L. 100 cm - 7 traverses</b></p> <p>P. 35 cm 4 226 092</p> <p>P. 50 cm 4 226 093</p> <p>P. 70 cm 4 226 094</p> <p><b>H. 250 cm - L. 125 cm - 7 traverses</b></p> <p>P. 35 cm 4 226 098</p> <p>P. 50 cm 4 226 099</p> <p>P. 70 cm 4 226 100</p>						

## OPTIONS

### Traverses supplémentaires



### Dessus Isorel



OPTIONS	Traverses supplémentaires		Dessus Isorel	
	Réf. + ZJ		Réf. + XW	
<b>Lot de 2 traverses supplémentaires</b>				
L. 100 cm / P. 35 cm	4 226 062 + ZJ		4 271 058 + XW	
L. 100 cm / P. 50 cm	4 226 063 + ZJ		4 271 059 + XW	
L. 100 cm / P. 70 cm	4 226 064 + ZJ		4 271 060 + XW	
L. 125 cm / P. 35 cm	4 226 065 + ZJ		4 271 061 + XW	
L. 125 cm / P. 50 cm	4 226 066 + ZJ		4 271 062 + XW	
L. 125 cm / P. 70 cm	4 226 067 + ZJ		4 271 063 + XW	
<b>Lot de 5 traverses supplémentaires</b>				
L. 100 cm / P. 35 cm	4 271 049 + ZJ		4 226 044 + XW	
L. 100 cm / P. 50 cm	4 271 050 + ZJ		4 226 045 + XW	
L. 100 cm / P. 70 cm	4 271 051 + ZJ		4 226 046 + XW	
L. 125 cm / P. 35 cm	4 271 052 + ZJ		4 226 047 + XW	
L. 125 cm / P. 50 cm	4 271 053 + ZJ		4 226 048 + XW	
L. 125 cm / P. 70 cm	4 271 054 + ZJ		4 226 049 + XW	

## FINITIONS

Montants peints

Montants galvanisés



**SJ**  
Bleu



**SC**  
Gris anthracite



**ZJ**  
Acier galvanisé



STOCK

Dimensions traverses	Largeur hors tout		Largeur utile entre les montants	Charges utiles par tablette uniformément réparties	
	Élément départ	Élément suivant		P. 35 cm	P. 50-70 cm
L. 100 cm	104 cm	101 cm	96 cm	135 kg	200 kg
L. 125 cm	129 cm	126 cm	121 cm	110 kg	160 kg

## RAYONNAGES POLYVALENTS

**+** Rangement optimisé & accessible

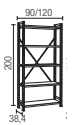

RAYONNAGES	DÉPART				SUIVANT			
	Réf. + SC		Réf. + SC		Réf. + SC		Réf. + SC	
		L. 90 cm		L. 120 cm		L. 90 cm		L. 120 cm
 <b>H. 200 cm</b>	5 tablettes	4 322 106		4 322 105		4 322 108		4 322 107
	6 tablettes	4 322 110		4 322 109		4 322 112		4 322 111
 <b>H. 250 cm</b>	7 tablettes	4 322 114		4 322 113		4 322 116		4 322 115
	8 tablettes	4 322 118		4 322 117		4 322 120		4 322 119

## OPTIONS

**Lot de 2 pièces de liaison d'angle 90°.** À fixer entre 1 élément départ et 1 suivant ou 2 éléments suivants (prévoir une tablette d'angle par niveau de tablette)

Réf. + SD

4 322 149

**Lot de 2 séparateurs coulissants**

H. 30 cm

4 412 032

**Lot de 2 tablettes supplémentaires**

L. 90 cm

4 322 144

L. 120 cm

4 322 143

Prix hors taxes :

En stock

Sur délai

Dimensions	Largeur hors tout		Largeur utile entre les montants	Charges utiles par tablette uniformément réparties
	Élément départ	Élément suivant		
L. 90 cm	96 cm	92 cm	88,5 cm	120 kg
L. 120 cm	126 cm	122 cm	118,5 cm	80 kg

## FINITIONS



SC  
Gris anthracite

STOCK



# VESTIAIRES SPÉCIFIQUES

## + Vestiaires démontables multi-cases



	Réf. + fin.	
<b>2 cases - L. 30 cm</b>		
Départ	4 229 024	
Suivant	4 229 026	
<b>4 cases - L. 40 cm</b>		
Départ	4 229 025	
Suivant	4 229 027	

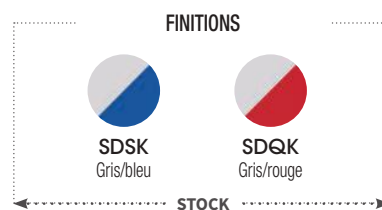
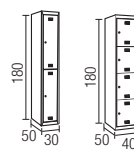

# BANCS



**Structure métal**  
en tube carré  
finition gris clair

**Vérins**  
de réglage

Assise constituée  
de **3 lattes en bois**  
hêtre clair verni

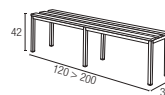

	Réf.	
L. 120 cm	4 410 077 + SD	
L. 160 cm	4 410 078 + SD	
L. 200 cm	4 410 079 + SD	

# VESTIAIRES INDUSTRIELS

+ Sécurisé & simple

## Industrie propre

Vestiaires équipés d'une tablette avec tringle porte-cintres



Porte-étiquette embouti  
(étiquette non fournie)

Ventilation en partie haute,  
basse et à l'arrière

## Industrie salissante

Séparation médiane dans les vestiaires industrie salissante pour protéger les vêtements de ville



Fermeture par morillon  
porte-cadenas  
(cadenas non fourni)



# TARIF

En stock

Sur délai

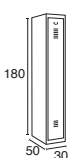
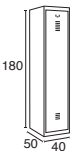
VESTIAIRES INDUSTRIELS		Démontables		Monoblocs	
		Réf. + fin.		Réf. + fin.	
	<b>Industrie propre</b>				
	Départ - L. 30 cm	4 228 089		1 porte L. 31,5 cm	4 424 037
	Suivant - L. 30 cm	4 228 090		2 portes L. 63 cm	4 424 038
				3 portes L. 94,5 cm	4 424 039
				4 portes L. 126 cm	4 424 040
	<b>Industrie salissante</b>				
	Départ - L. 40 cm	4 228 091		1 porte L. 41,5 cm	4 424 041
	Suivant - L. 40 cm	4 228 092		2 portes L. 83 cm	4 424 042
				3 portes L. 124,5 cm	4 424 043

OPTIONS		Démontables		Monoblocs	
		Réf. + SD		Réf. + SD	
	<b>Toits en pente. H. 20 x P. 50 cm</b> - Empêchent le dépôt d'objets au-dessus des vestiaires - Finition gris clair				
	L. 60 cm	4 410 052		L. 63 cm	4 410 056
	L. 80 cm	4 410 053		L. 83 cm	4 410 057
	L. 90 cm	4 410 054		L. 94,5 cm	4 410 058
	L. 120 cm - industrie propre	4 410 055		L. 126 cm - industrie propre	4 410 059
	L. 120 cm - industrie salissante	4 410 084		L. 124,5 cm - industrie salissante	4 410 085

**Socles** - Permettent la circulation d'air et le nettoyage sous les vestiaires. Se positionnent sous un élément départ (obligatoire) + des éléments suivants. Finition gris clair

**Socles banc. H. 35 x P. 80 cm**



L. 60 cm	4 410 062	L. 63 cm	4 410 066
L. 80 cm	4 410 063	L. 83 cm	4 410 067
L. 90 cm	4 410 064	L. 94,5 cm	4 410 068
L. 120 cm - industrie propre	4 410 061	L. 126 cm - industrie propre	4 410 081
L. 120 cm - industrie salissante	4 410 080	L. 124,5 cm - industrie salissante	4 410 065

**Socles pieds. H. 15 x P. 50 cm**



L. 60 cm	4 410 070	L. 63 cm	4 410 074
L. 80 cm	4 410 071	L. 83 cm	4 410 075
L. 90 cm	4 410 072	L. 94,5 cm	4 410 076
L. 120 cm - industrie propre	4 410 069	L. 126 cm - industrie propre	4 410 083
L. 120 cm - industrie salissante	4 410 082	L. 124,5 cm - industrie salissante	4 410 073

**Jeux de 4 pieds. H. 15 cm** - À prévoir tous les 120 cm. Finition gris clair



Démontable	4 410 050
Monobloc	4 410 051

**Serrure à clé** - 2 clés fournies - Serrure à code : nous consulter

4 410 086

**DÉCORS + FINITIONS**

Finitions de coffres et de portes (+ fin.)



**SDSD**  
Gris clair



**SDSK**  
Gris/bleu

**STOCK**