

# MULTI-MEETING



**Signature**  
— BY EOL —



## MODULAIRE & INTEMPORELLE

**G**râce à ses différentes formes et tailles de plateaux, la gamme MULTI-MEETING permet de créer des configurations de réunion variées et modulaires. Ses finitions nobles et ses pieds panneaux lui confèrent un style intemporel, alors que son piétement fuselé en métal lui apporte modernité. Ses solutions d'électrification rendent MULTI-MEETING idéale pour aménager de grands espaces de réunion.

---

## MODULAR & TIMELESS

**T**hanks to the variety of shapes and worktop dimensions available, the MULTI-MEETING range will allow you to create flexible and diverse meeting table configurations. A timeless design is achieved thanks to the use of high-quality noble materials and panel style legs, whereas the inclusion of tapered metal legs provides the option of a more contemporary appearance. Supported by a variety of power and data feed solutions, MULTI-MEETING is ideal for the furnishing of larger meeting rooms.

---

## MODULAIR & TIJDLOOS

**M**et de verschillende bladvormen en bladformaten stelt u met MULTI-MEETING gevarieerde en modulaire vergadertafels samen. De hoogwaardige afwerkingen en de paneelpoten staan voor een tijdloze stijl, terwijl de conische metalen poten voor een eigentijdser accent zorgen. De oplossingen voor kabelgeleiding en connectiek maken MULTI-MEETING ideaal voor de inrichting van grote vergaderruimten.

---

**CHOISIR** LA TAILLE ET LE STYLE DE SON ESPACE DE RÉUNION  
**CHOOSE** A SIZE AND STYLE FOR YOUR MEETING SPACE  
**KIES** DE CAPACITEIT EN DE STIJL VAN UW VERGADERRUIMTE



Table oblongue avec pieds panneaux, capacité 8 personnes  
Oblong table with panel legs, seats up to 8 people  
Langwerpige tafel met paneelpoten, capaciteit 8 personen



Table elliptique avec pieds métal, capacité 12 personnes  
Elliptical shaped table with metal legs, seats up to 12 people  
Ellipsvormige tafel met metalen poten, capaciteit 12 personen

**CHOISIR** LA CONFIGURATION DE SON ESPACE DE RÉUNION  
**CHOOSE** THE RIGHT CONFIGURATION FOR YOUR MEETING SPACE  
**KIES** DE OPSTELLING VAN UW VERGADERRUIMTE



Table en U, capacité 12 personnes  
U-shaped table, seats up to 12 people  
U-vormige tafel, capaciteit 12 personen



Table en rond, capacité 8 personnes  
Circular shaped table, seats up to 8 people  
Ronde tafel, capaciteit 8 personen

**PERSONNALISER** MULTI-MEETING  
**CUSTOMISE** MULTI-MEETING  
MULTI-MEETING **PERSONALISEREN**



Spécialement conçue pour les espaces de réunion, MULTI-MEETING offre des solutions d'électrification astucieuses facilitant les connexions informatiques et permettant une gestion des câbles plus esthétique.

Specially designed for meeting spaces, MULTI-MEETING offers ingenious power and cable management solutions, facilitating data connectivity from the worktop and helping to conceal unsightly wiring and cables.

MULTI-MEETING werd volledig ontwikkeld in functie van de vergaderruimte en kan vervolledigd worden met een aantal slimme en nette oplossingen voor connectiek en kabelgeleiding.



## Accessoires - Accessories - Accessoires

---



Voile de fond métal (non compatible avec version trappe)  
Metal modesty panel (not compatible with version featuring top access module)  
Metalen frontpaneel (niet combineerbaar met versie met technisch luik)

## Électrification - Power and cable management - Kabelgeleiding

---



Kit goulotte et top access central <sup>(1)</sup>  
Cable trough kit and centrally mounted top access module <sup>(1)</sup>  
Set bestaande uit kabelgoot en centrale top <sup>(1)</sup>



Goulotte simple  
Standard cable trough  
Kabelgoot

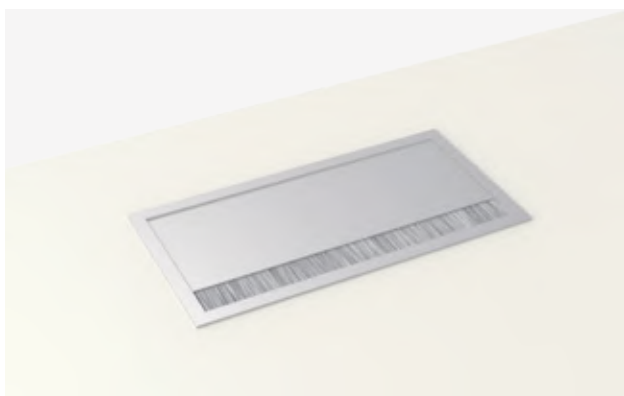

Trappe soft closing sans nourrice <sup>(2)</sup>  
Soft closing top access housing without socket feed <sup>(2)</sup>  
Soft closing technisch luik zonder voeding <sup>(2)</sup>



Trappe soft closing avec nourrices <sup>(2)</sup>  
Soft closing top access housing with socket feed <sup>(2)</sup>  
Soft closing technisch luik met voeding <sup>(2)</sup>

(1) Uniquement pour tables elliptiques - Only on elliptical shaped tables - Enkel voor ellipsvormige tafels

(2) Uniquement pour les plateaux rectangulaires et cintrés - Only on tables with rectangular or curved worktops - Enkel voor rechthoekige en boogvormige bladen

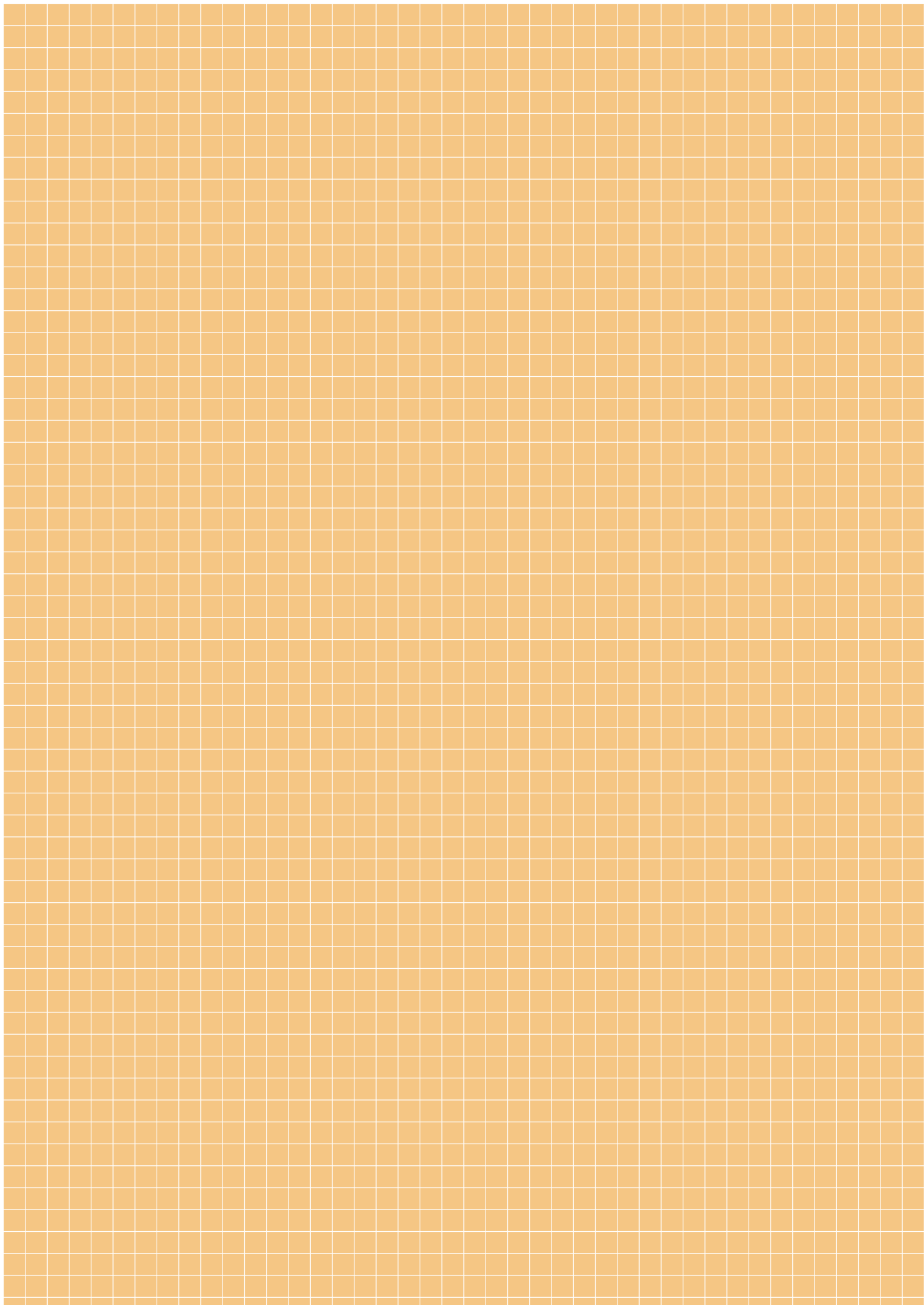

**SYNTHÈSE** & DIMENSIONS

—

**SUMMARY** & DIMENSIONS

**OVERZICHT** & AFMETINGEN

# GAMME RANGE COLLECTIE

Plateaux - Worktops - Bladen

---



Rectangulaires  
Rectangular  
Rechthoekig



Cintré symétrique  
Symmetrical curved  
Symmetrisch boogvormig



Cintré droit ou gauche  
Curved to right or left  
Boogvormig rechts of links



Angle (fermé)  
Corner angle (closed)  
Hoek (gesloten)



Angle (ouvert)  
Corner angle (open)  
Hoek (open)



Ellipse  
Elliptical  
Ellips



Trapèze  
Trapeziform  
Trapezium

## Piétements - Legs - Poten

---



Panneau mélamine  
Melamine panel legs  
Melamine paneelpoten



Pieds métal  
Metal legs  
Metalen poten



Pieds métal avec carter amovible  
permettant la gestion des câbles  
Metal legs incorporating a removable  
cable management housing cover  
Metalen poten met afneembare  
kabelgeleiding

# SYNOPTIQUE OVERVIEW OVERZICHT

Plateaux (ép. 30 et 38 mm) - Worktops (30 and 38 mm thick) - Bladen (dikte 30 en 38 mm)

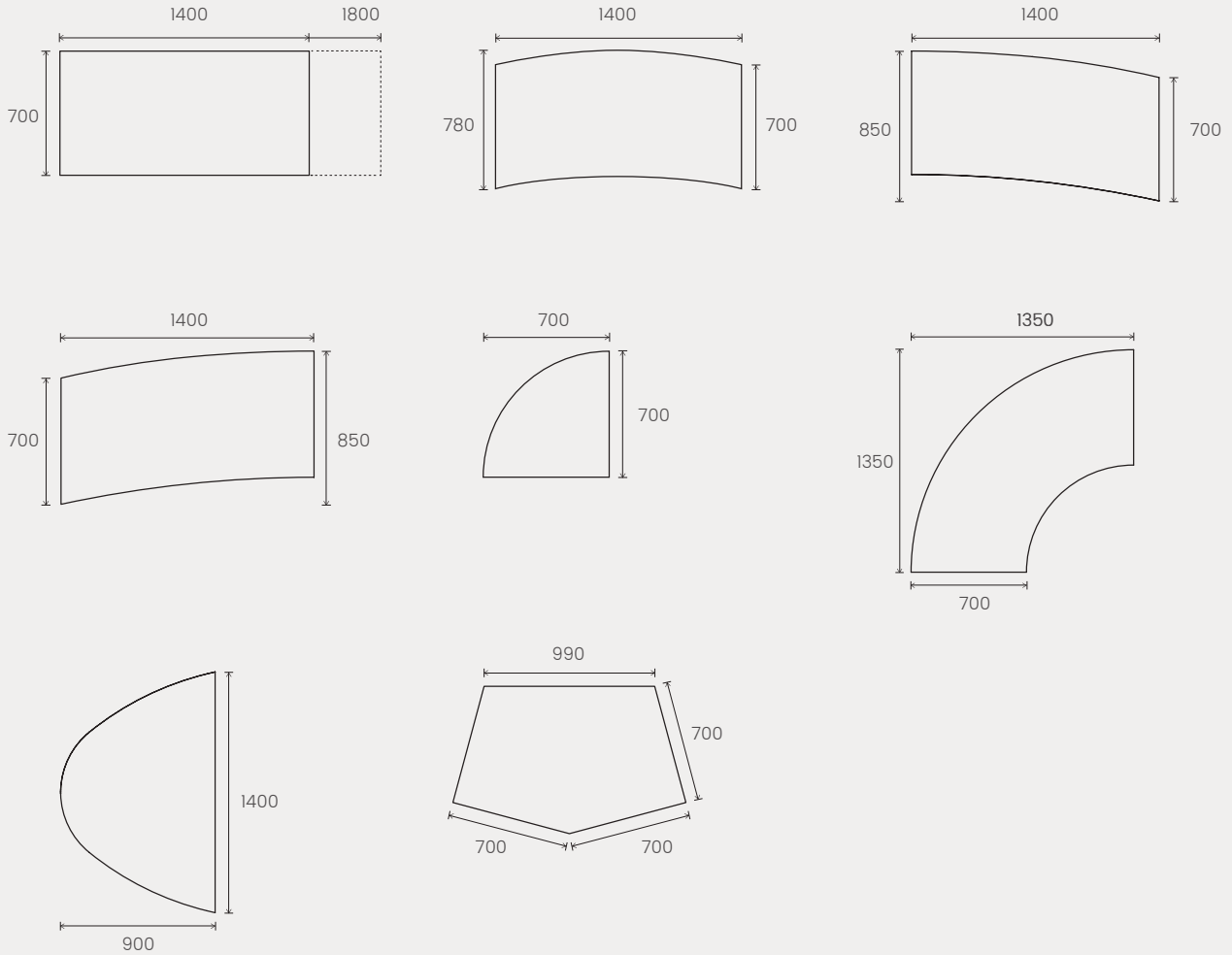

Piétements - Legs - Poten

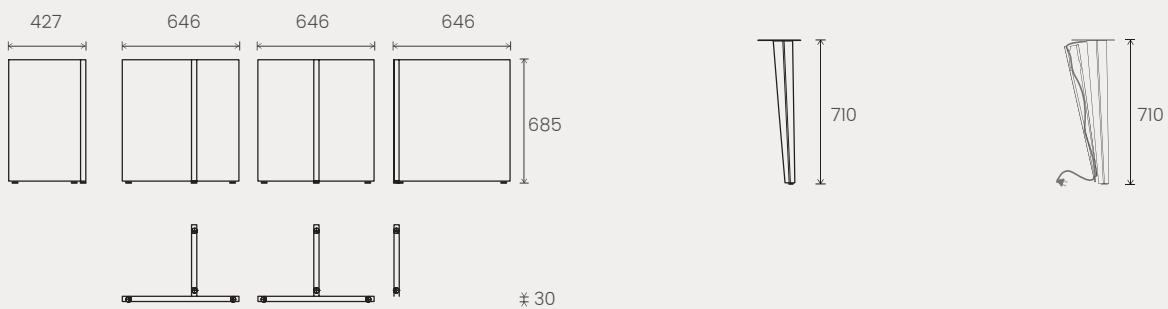

# Configurations - Configurations - Opstellingen

4 à 6 personnes - 4 to 6 people - 4 tot 6 personen

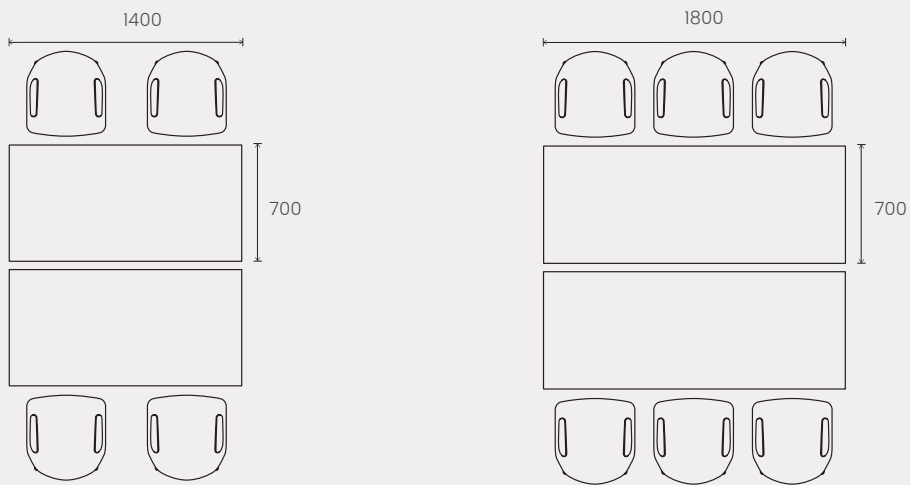

10 personnes - 10 people - 10 personen

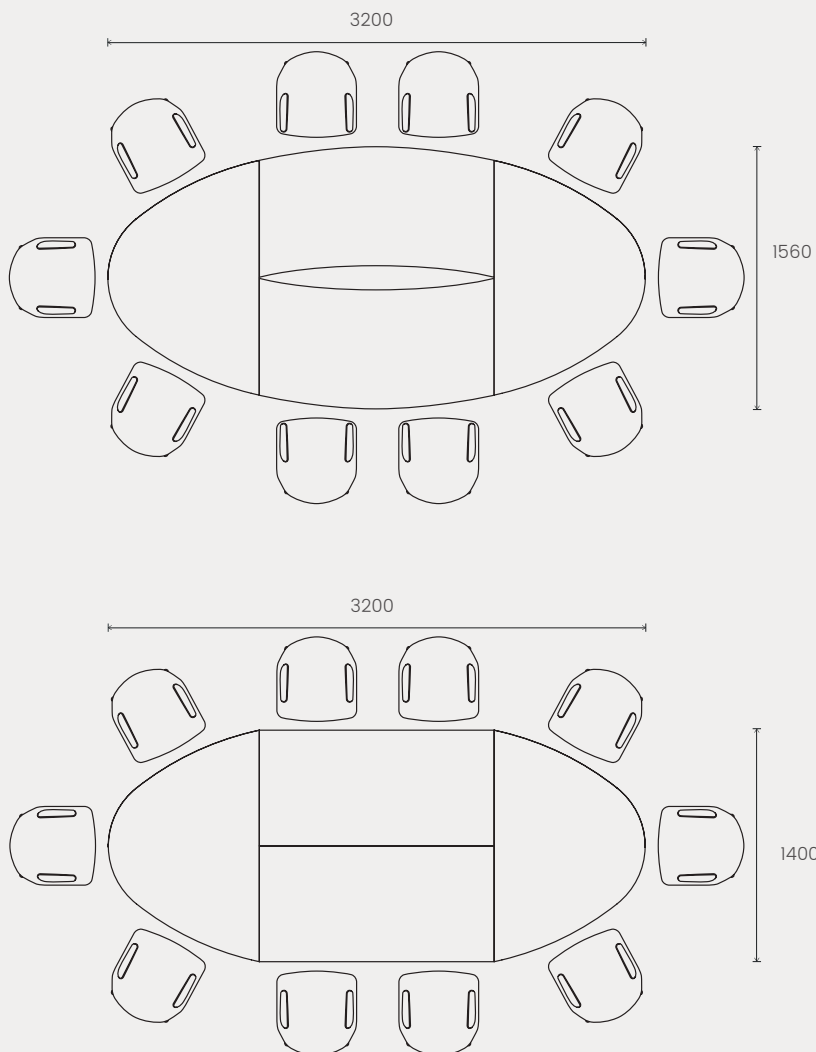

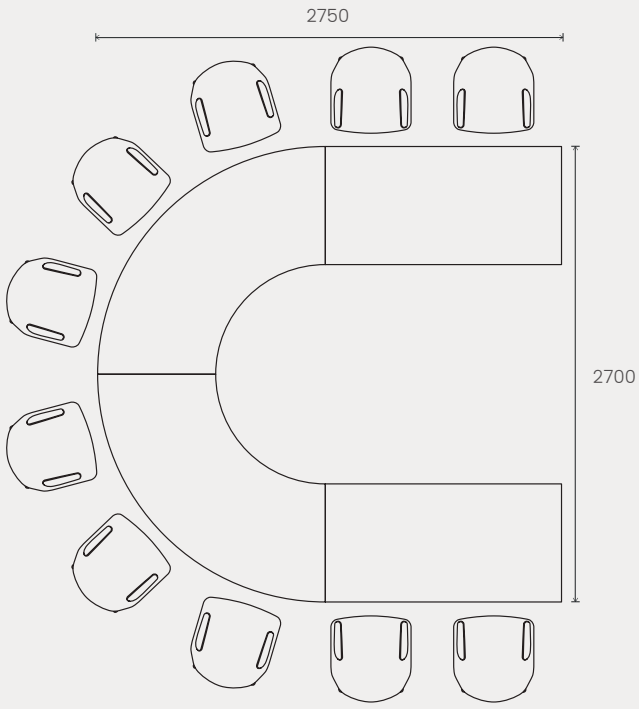

12 personnes - 12 people - 12 personen

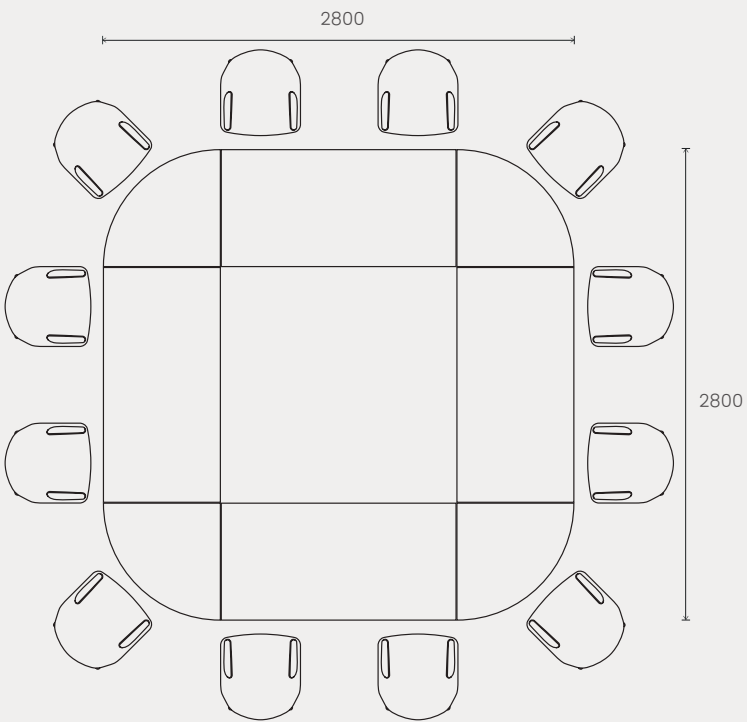



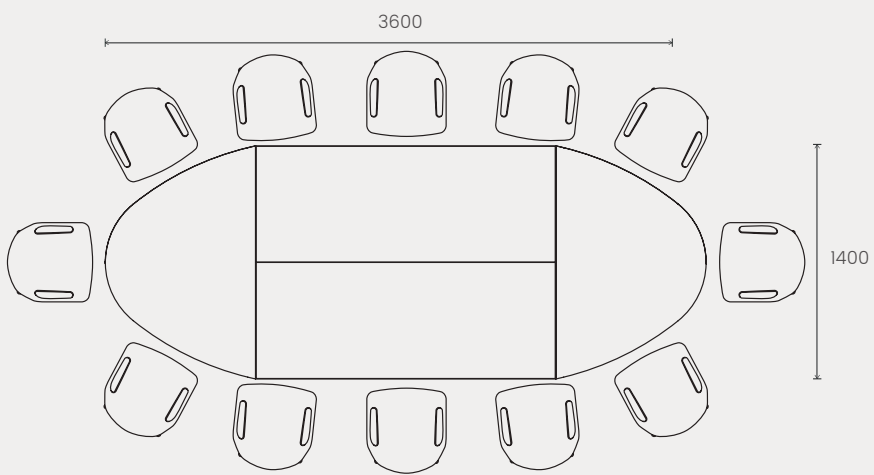
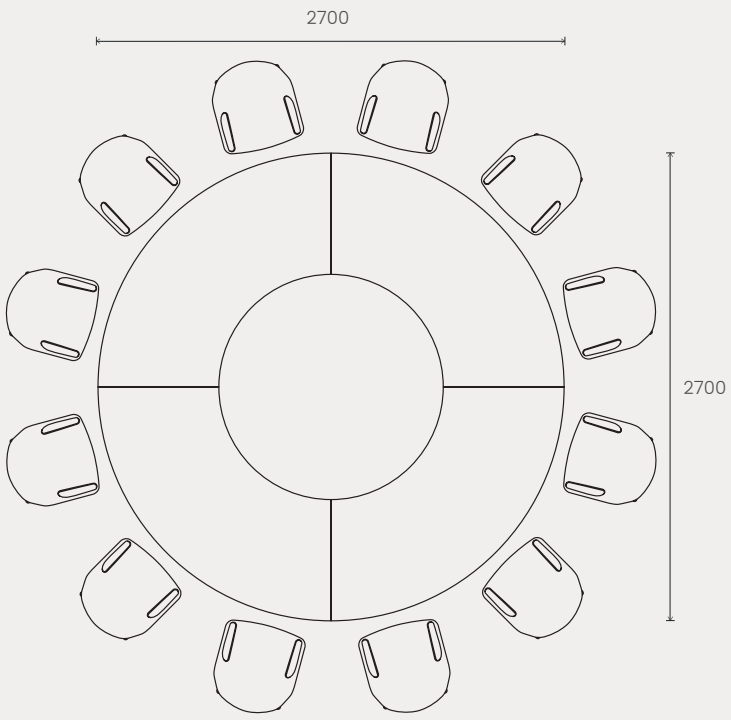

14 personnes - 14 people - 14 personen

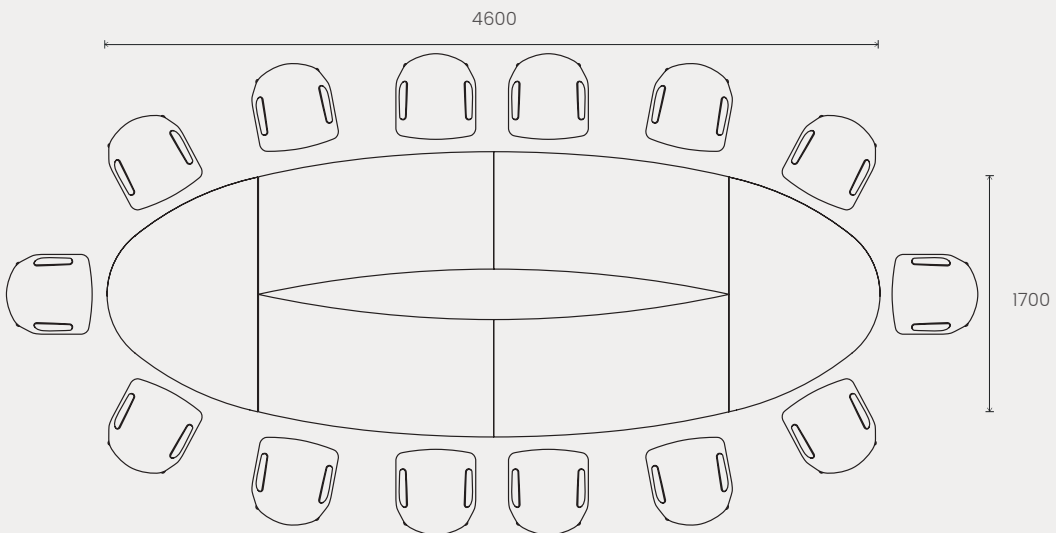

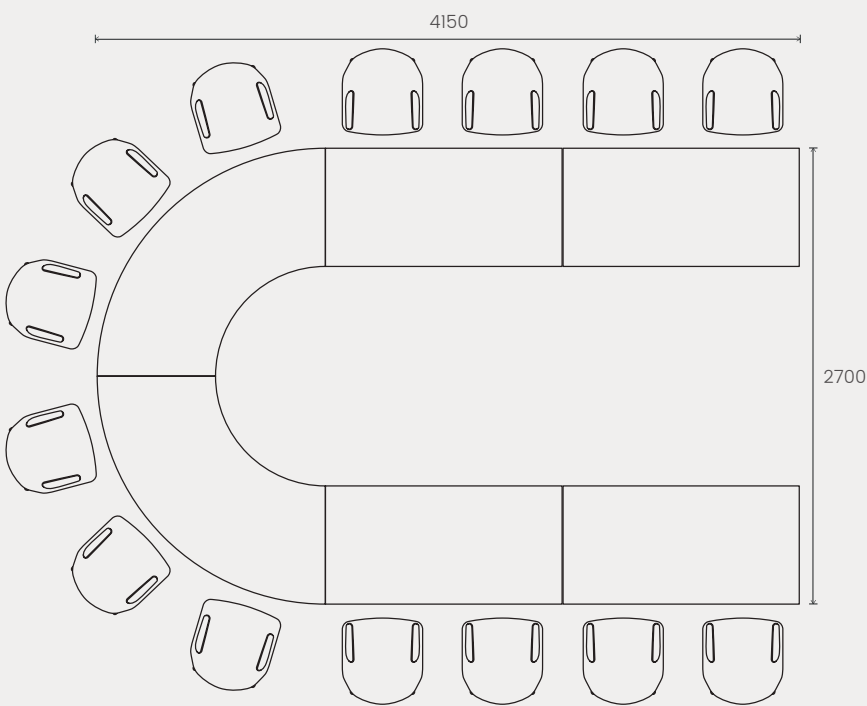
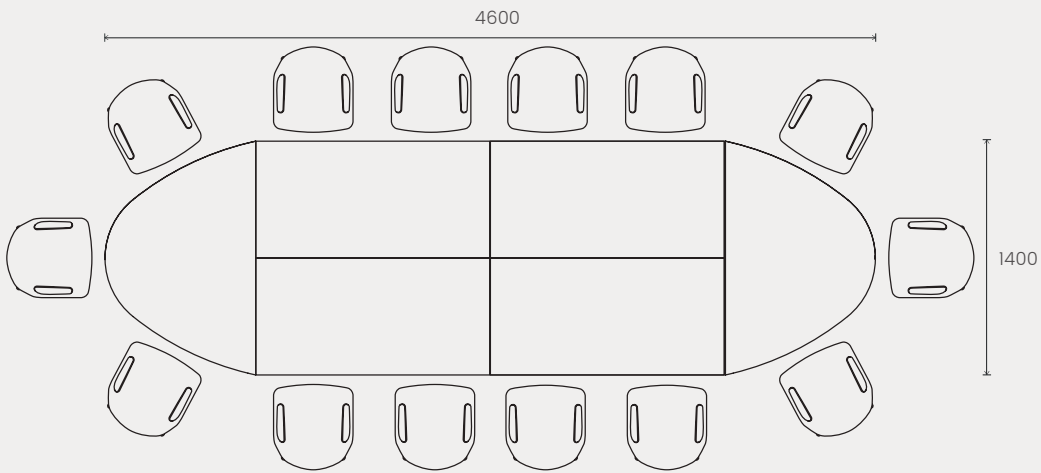

18 personnes - 18 people - 18 personen

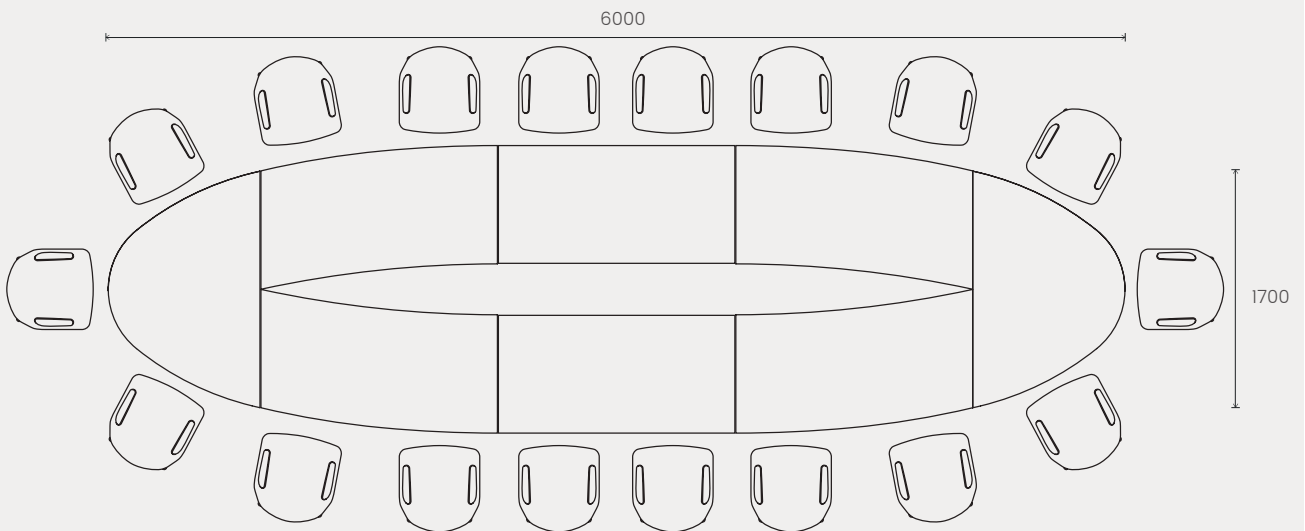

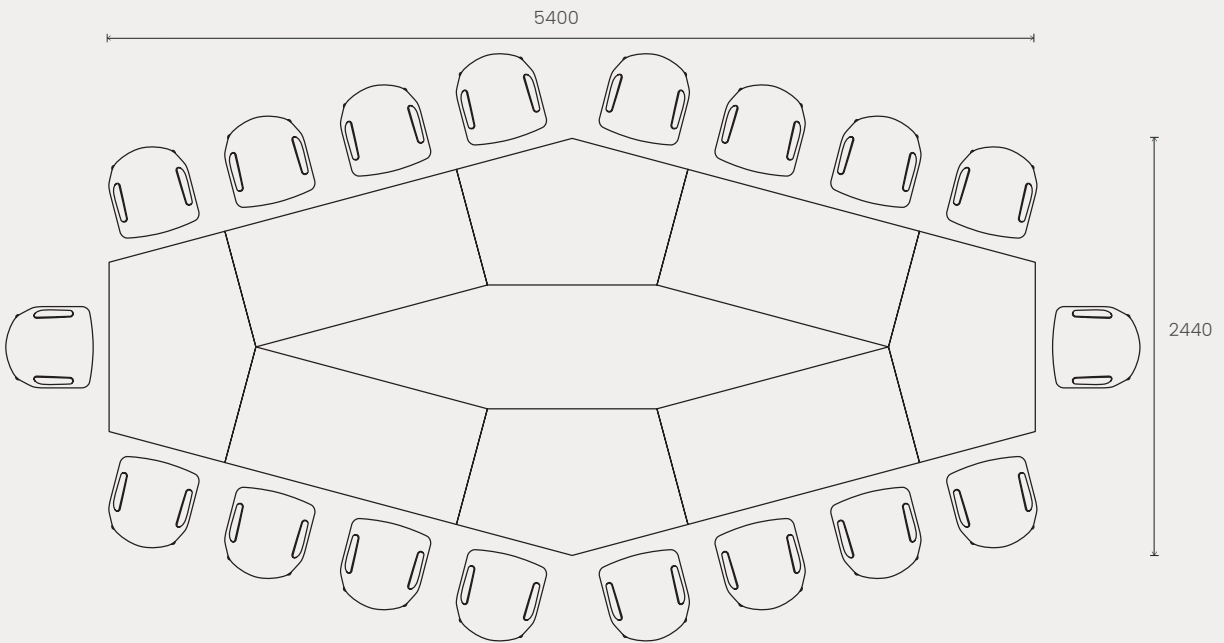
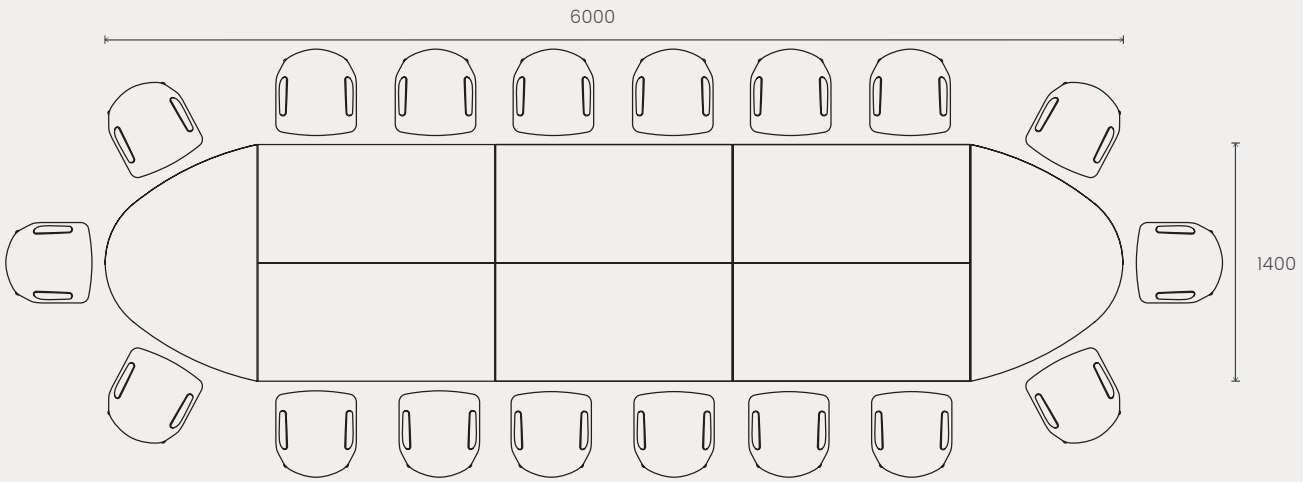

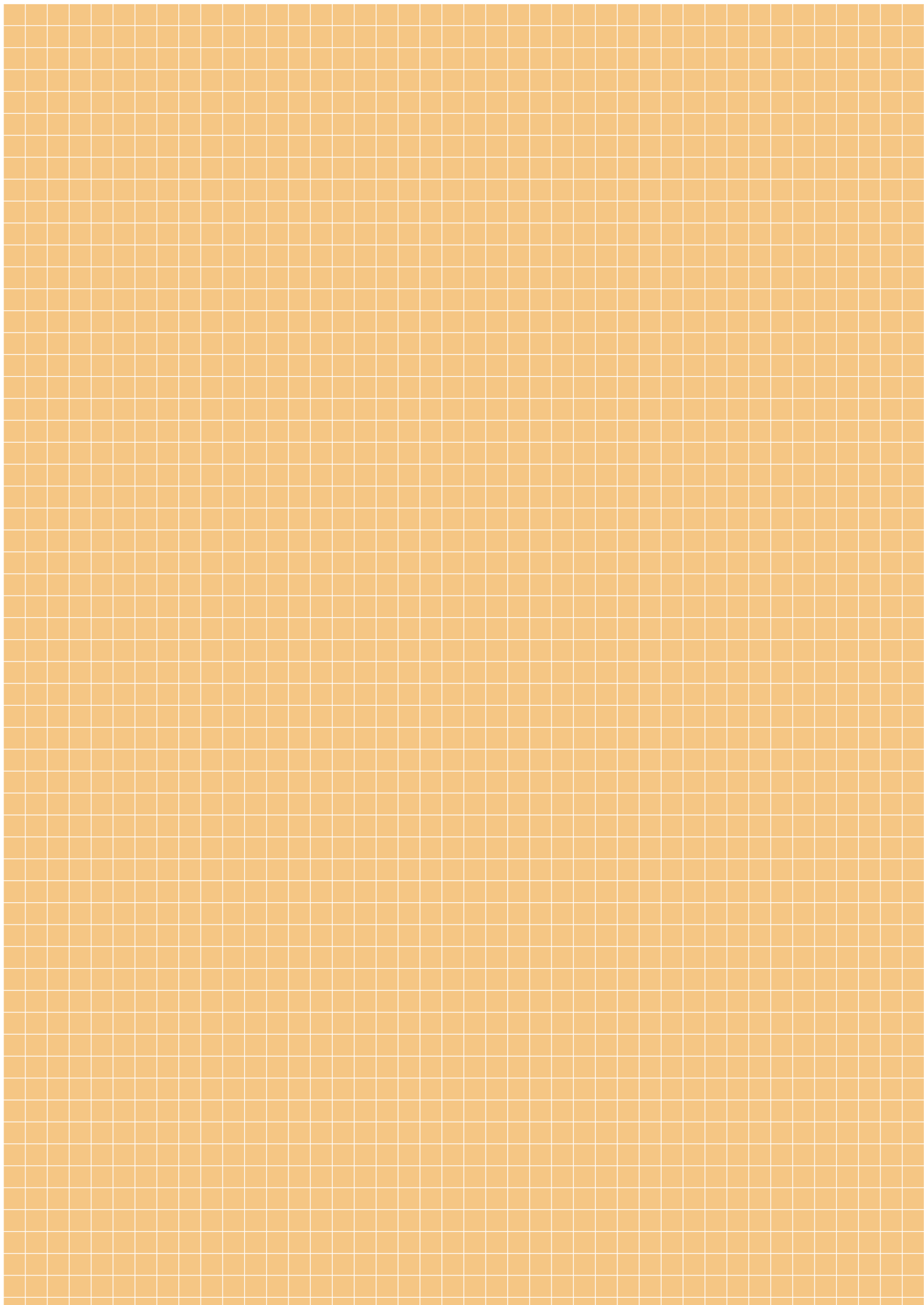

**MATIÈRES & COULEURS**

—

**MATERIALS & COLOURS**

**MATERIALEN & KLEUREN**

1. MÉLAMINE (plateaux ép. 38 mm et pieds panneaux) – MELAMINE (worktops 38 mm thick and panel legs) – MELAMINE (bladen dikte 38 mm en paneelpoten)

ÉP. 38 MM



ÉP. 30 MM



2. MÉTAL (piétements) – METAL (legs) – METAAL (poten)

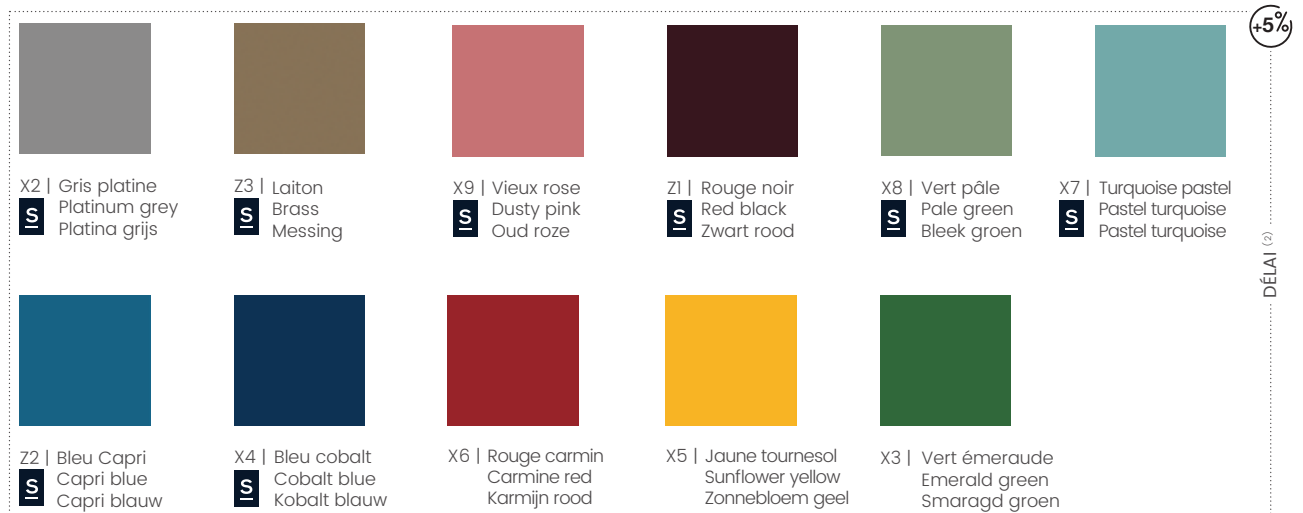
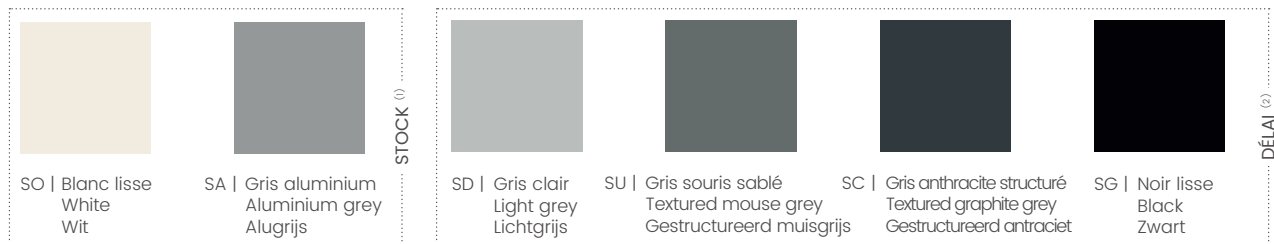

**+5%** majoration de 5% sur le PP HT indiqué  
5% mark-up on the RRP excl. tax  
meerprijs van 5% op de opgegeven verkoprijks excl. BTW

<sup>(1)</sup> STOCK / STOCK / VOORRAAD  
<sup>(2)</sup> DÉLAI / ON REQUEST / MET LEVERTIJD

**IS** Exclusivité / Exclusive to / Exclusiviteit  
SIGNATURE BY EOL



# TABLES POLYVALENTES

Grâce à la diversité de leurs formes et dimensions, les tables polyvalentes permettent de multiples configurations pour aménager vos espaces de réunion.

**+** Légères et modulaires

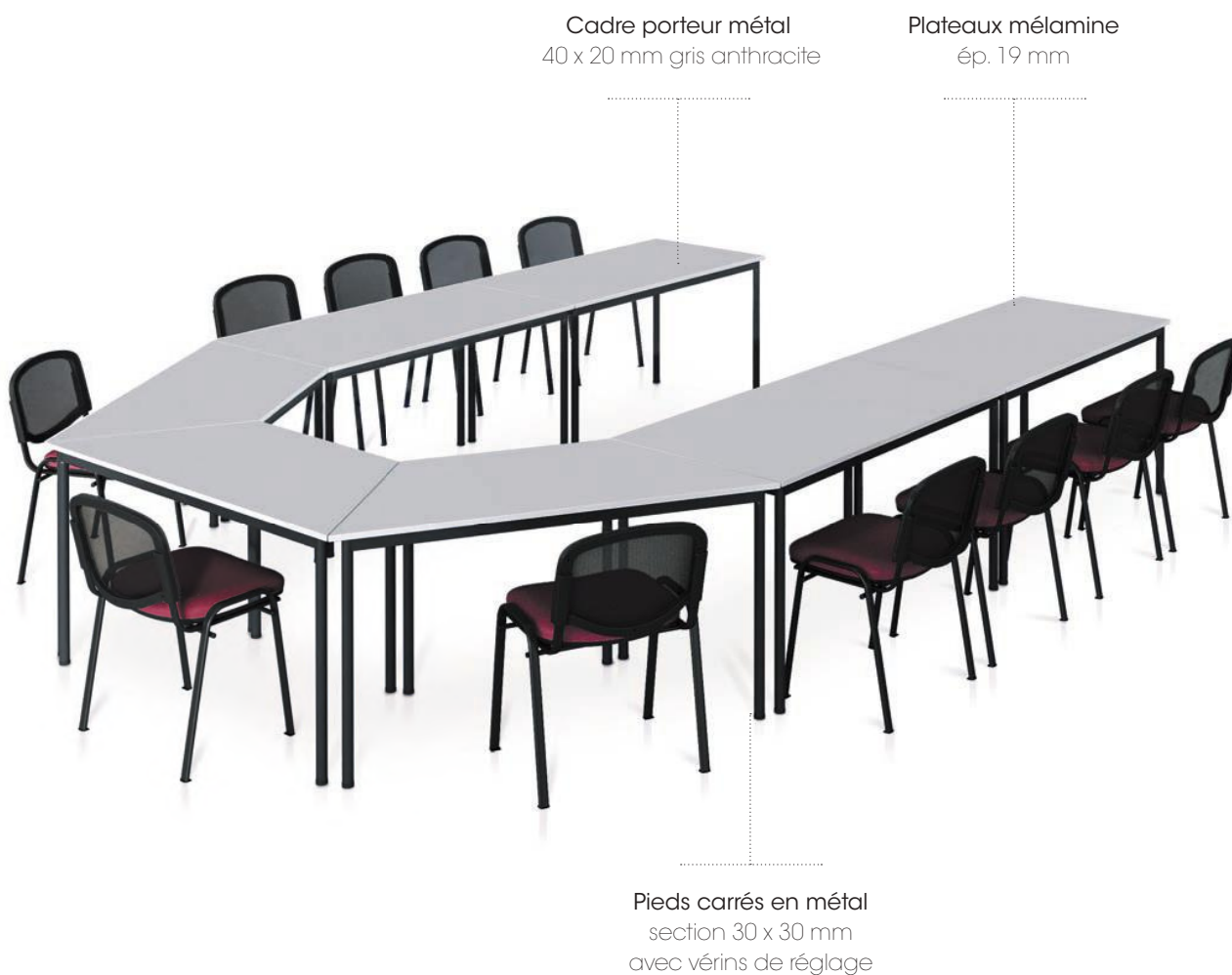



# FINITIONS & SYNOPTIQUE

4

décor  
mélamine  
de plateaux  
(+ décor)

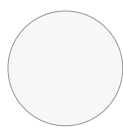

**MG**  
Blanc neige

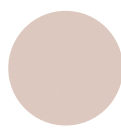

**M6**  
Gris cachemire

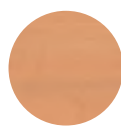

**R2**  
Hêtre de Honfleur



**RI**  
Chêne clair

STOCK

3

finitions  
métal pour  
piètements  
(+ fin.)

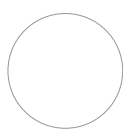

**SO**  
Blanc



**SA**  
Gris aluminium



**SC**  
Gris anthracite

STOCK

Plans droits

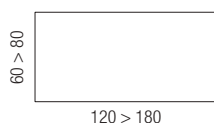

Plans demi-lune

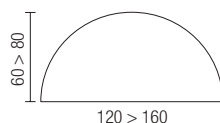

Plans trapèzes

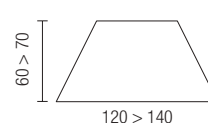

## TARIF

En stock

### TABLES RECTANGULAIRES



L. 120 x P. 60 cm

Réf. + décor + fin.

6 298 013

L. 140 x P. 70 cm

6 298 017

L. 160 x P. 80 cm

6 298 021

L. 180 x P. 80 cm

6 298 024

### TABLES DEMI-LUNE



L. 120 x P. 60 cm

6 298 001

L. 140 x P. 70 cm

6 298 005

L. 160 x P. 80 cm

6 298 009

### TABLES TRAPÈZES



L. 120 x P. 60 cm

6 298 025

L. 140 x P. 70 cm

6 298 029